



LEGNOLANDIA

didactia

Proveedor Integral, S. L.

didactia@didactiaweb.com - www.didactiaweb.com

931 944 139 - 623 214 166

CATALOGO GIOCHI PLAYGROUNDS CATALOGUE

SCHEDE RIASSUNTIVE

SUMMARY SHEETS

Linea Trees	p. 34	Linea Trees
Altalene e Funivie	p. 36	Swings and Cableways
Arrampicate	p. 37	Climbing Frames
Cassette e Capanne	p. 38	Play Houses And Huts
Dondoli	p. 39	Seesaws
Giostre	p. 39	Roundabouts
Giochi a Molla	p. 40	Spring Rockers
Equilibrio e Fantasia	p. 42	Balancing and Fantasy
Orti Didattici	p. 46	Educational Gardens
Tunnel Labirinti e Piste	p. 44	Tunnel, Mazes and Tracks
Sabbia e Acqua	p. 45	Sand and Water
Scivoli	p. 47	Slides
Foglie	p. 49	Foglie
Torri	p. 48	Towers
Castelli	p. 49	Castles
Castelli Colore	p. 51	Colour Castles
Easy Adventure	p. 54	Easy Adventure
I love wood	p. 52	I love wood
Argentovivo	p. 54	Argentovivo
Linea Camelot	p. 52	Camelot Line
Linea Tuttifrutti	p. 53	Tuttifrutti Line
Impianti Ginnici	p. 54	Sport & Gym
Arredo Scuole	p. 55	School Furnishing
Arredo Parco	p. 56	Park Furnishing
Segnaletica	p. 58	Signboards
Recinti	p. 59	Fencing

Linea Trees

Trees Line

<p>art. 011500 pag. 66</p> <p>Tree Swing</p>  <p>3-6 anni 260x46h190cm</p>	<p>art. 011501 pag. 66</p> <p>Tree Swing Secur</p>  <p>1-5 anni 260x46h190cm</p>	<p>art. 011505 pag. 68</p> <p>Tree Tower 80-2</p>  <p>2-5 anni 195x387h161cm</p>	<p>art. 011510 pag. 67</p> <p>Tree Tower 100-2</p>  <p>2-5 anni 195x396h200cm</p>	<p>art. 011511 pag. 67</p> <p>Tree Tower 100-3</p>  <p>2-5 anni 195x379h200cm</p>	<p>art. 011515 pag. 69</p> <p>Tree Tower 100T-1</p>  <p>2-6 anni 195x379h278cm</p>
<p>art. 011530 pag. 70</p> <p>Tree Tower 150-2</p>  <p>3-12 anni 195x423h250cm</p>	<p>art. 011529 pag. 70</p> <p>Tree Tower 150-3</p>  <p>3-12 anni 195x522h250cm</p>	<p>art. 011531 pag. 70</p> <p>Tree Tower 150-4</p>  <p>3-12 anni 195x534h250cm</p>	<p>art. 011545 pag. 71</p> <p>Tree Tower 150T-2</p>  <p>3-12 anni 195x455h328cm</p>	<p>art. 011550 pag. 71</p> <p>Tree Tower 150T-4</p>  <p>3-12 anni 195x495h328cm</p>	<p>art. 011551 pag. 71</p> <p>Tree Tower 150T-6</p>  <p>3-12 anni 195x527h328cm</p>
<p>art. 011560 pag. 72</p> <p>Tree Tower 200-2</p>  <p>5-12 anni 195x616h300cm</p>	<p>art. 011559 pag. 72</p> <p>Tree Tower 200-3</p>  <p>3-12 anni 195x693h300cm</p>	<p>art. 011561 pag. 73</p> <p>Tree Tower 200T-2</p>  <p>5-12 anni 195x616h378cm</p>	<p>art. 011565 pag. 73</p> <p>Tree Tower 200T-6</p>  <p>3-12 anni 195x643h378cm</p>	<p>art. 011563 pag. 74</p> <p>Tree Tower 200T-4</p>  <p>3-12 anni 343x473h378cm</p>	<p>art. 011564 pag. 74</p> <p>Tree Tower 200T-8</p>  <p>3-12 anni 246x500h378cm</p>

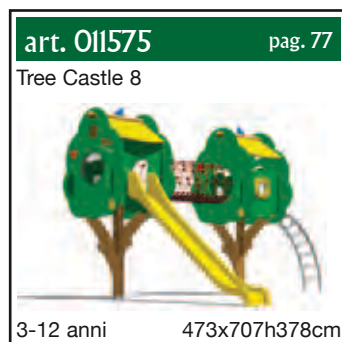

MODELLI

Trees sono vere e proprie case sugli alberi, dotate di piattaforme molto più spaziose degli standard abituali. L'esclusiva struttura a singolo pilastro, realizzata interamente in legno lamellare incastrato, è progettata per resistere a tutti i sovraccarichi e all'insidia del tempo senza la necessità di particolare manutenzione. Le strutture offrono diversi gradi di difficoltà, dalle più piccole, studiate per le scuole, agli alberi più grandi dedicati ai parchi pubblici. La linea Trees include inoltre alcuni articoli che rispettano le linee guida del progetto europeo "Play for all" teso alla creazione di parchi gioco fruibili da bambini con ogni tipo di abilità.









Trees are real tree houses with platforms much larger than the common standards. The unique structure with a single pillar is entirely made of glulam wood.

It is designed to withstand all overloads and dangers of weather without the need for special maintenance. The playground structures offer different degrees of difficulty, from the smallest tree tower, designed for schools, to the bigger trees which are dedicated to public parks. Our trees line also includes some items that meet the guidelines of the European project "Play for all" aimed at the creation of playgrounds accessible to children with any kind of ability.

LEGNOLANDIA

Altalene e Funivie

Swings and Cableways

<p>art. OI1046 pag. 82</p> <p>Altalena Minny</p>  <p>3-11 anni 14x250h230cm</p>	<p>art. OI1045 pag. 82</p> <p>Altalena Singola Classic</p>  <p>3-14 anni 215x300h235cm</p>	<p>art. OI1050 pag. 83</p> <p>Altalena Doppia Classic</p>  <p>3-14 anni 215x400h235cm</p>	<p>art. OI1049 pag. 83</p> <p>Altalena Doppia Mix Classic</p>  <p>2-14 anni 215x400cm</p>	<p>art. OI1149 pag. 83</p> <p>Altalena Doppia Secur Classic</p>  <p>2-5 anni 215x400h235cm</p>	<p>art. OI1250 pag. 84</p> <p>Altalena Cestone Classic</p>  <p>2-11 anni 215x400h235cm</p>
<p>art. OI1255 pag. 86</p> <p>Altalena Canapone</p>  <p>3-11 anni 191x350h242cm</p>	<p>art. OI1252 pag. 85</p> <p>Altalena Pendolone</p>  <p>3-14 anni 565x249h313cm</p>	<p>art. OI5001 pag. 144</p> <p>Altalena Singola Young</p>  <p>3-11 anni 308x154h218cm</p>	<p>art. OI5017 pag. 144</p> <p>Altalena Singola Secur Young</p>  <p>2-5 anni 308x154h218cm</p>	<p>art. OI5000 pag. 145</p> <p>Altalena Doppia Young</p>  <p>3-11 anni 398x154h218cm</p>	<p>art. OI5002 pag. 145</p> <p>Altalena Doppia Mix Young</p>  <p>2-11 anni 398x154h218cm</p>
<p>art. OI5004 pag. 145</p> <p>Altalena Doppia Secur Young</p>  <p>2-5 anni 398x154h218cm</p>	<p>art. OI5009 pag. 146</p> <p>Altalena Cestone Young</p>  <p>2-8 anni 398x155h220cm</p>	<p>art. OI6081 pag. 148</p> <p>Altalena Singola Fruts</p>  <p>3-8 anni 254x157h205cm</p>	<p>art. OI6082 pag. 148</p> <p>Altalena Singola Secur Fruts</p>  <p>2-5 anni 254x157h205cm</p>	<p>art. OI6083 pag. 149</p> <p>Altalena Doppia Fruts</p>  <p>3-8 anni 344x157h205cm</p>	<p>art. OI6084 pag. 149</p> <p>Altalena Doppia Mix Fruts</p>  <p>2-8 anni 344x157h205cm</p>

art. 016085 pag. 149
 Altalena Doppia Secur Fruts



2-5 anni 344x157h205cm

art. 011224 pag. 88
 Funivia 30 metri senza rampe



5-14 anni 300x300h290cm

art. 011228 pag. 89
 Funivia 30 metri con una rampa



5-14 anni 300x300h380cm

Arrampicate Climbing Frames

art. 011085 pag. 87
 Totem



3-14 anni 16x50h200cm

art. 011074 pag. 90
 Arrampicata Climber



da 4 anni 14x158h230cm

art. 011225 pag. 90
 Dolomiti Climb



da 4 anni Ø290h250cm

art. 011218 pag. 91
 Boulder Wall



da 6 anni 650x200h280cm

art. 011317 pag. 92
 Vita Park Station



da 4 anni 945x1064xh238cm

art. 011160 pag. 93
 Combigym



3-14 anni 152x300h237cm

art. 011162 pag. 93
 Combigym Plus



da 3 anni 152x500h237cm

art. 012084 pag. 94
 Net Mountain 250

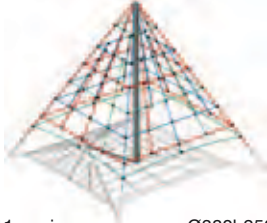

5-11 anni Ø380h250cm

art. 012085 pag. 94
 Net Mountain 300

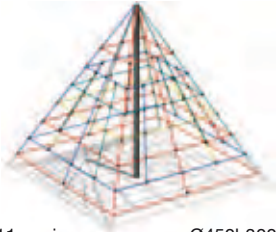

5-11 anni Ø450h300cm

art. 012086 pag. 95
 Net Mountain Maxi

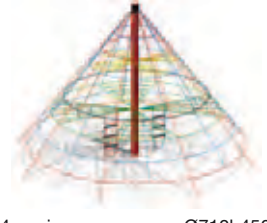

6-14 anni Ø710h450cm

art. 012087 pag. 95
 Net Mountain Galaxy

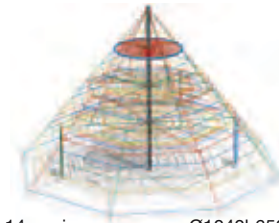

6-14 anni Ø1040h650cm

art. 015006 pag. 156
 Palesta Esagonale Young



3-11 anni Ø230h209cm

art. 015019 pag. 156
Palesta Esagonale Young Climb



3-11 anni 222x192h209cm

art. 015026 pag. 147
Arrampicata Mista Young



3-11 anni 125x195h200cm

art. 017201 pag. 228
Banana Climb



2-6 anni 85x85h55/69cm

art. 017205 pag. 228
Mandarino Climb



1-3 anni 80x82h65cm

Casette e Capanne

Play Houses and Huts

art. 011014 pag. 99
Baby Tent



2-11anni 200x200h163cm

art. 011018 pag. 98
Play Tent Plus



3-14 anni 314x224h205cm

art. 011019 pag. 99
Rifugio Natura



2-11 anni 192x212h204cm

art. 011010 pag. 100
Play House



2-14 anni 200x350h200cm

art. 012050 pag. 101
Joy House



2-8 anni 148x157h152cm

art. 015007 pag. 164
Casetta Midi



2-11 anni 130x130h215cm

art. 015018 pag. 165
Casetta Esagonale Young



2-11 anni 271x358h293cm

Dondoli Seesaws

art. 011096 pag. 102
Dondolo a 2 Posti Fisso



3-12 anni 300x53h75cm

art. 011100 pag. 102
Dondolo a 4 Posti Fisso



3-12 anni 400x53h75cm

art. 011432 pag. 103
Twin Parrot



2-8 anni 250x25h85cm

art. 011433 pag. 103
Twin Think



2-8 anni 130x100h85cm

art. 011217 pag. 103
Coccodrillo Spring



2-8 anni 300x36h69cm

Giostre Roundabouts

art. 011208 pag. 115
Giostra Compass



3-8 anni Ø140xh74cm

art. 012410 pag. 114
Giostra Fiorella



3-8 anni Ø140xh94cm

art. 012184 pag. 97
Space Ship - K



3-11 anni Ø160xh150cm

art. 012185 pag. 97
Space Ship - A



3-11 anni Ø200xh300cm

art. 012187 pag. 97
Space Ship - C



3-11 anni Ø160xh300cm

Giochi a Molla

Spring Rockers

<p>art. OI1401 pag. 104</p> <p>Think Spring 1</p>  <p>2-9 anni 23x70h87cm</p>	<p>art. OI1403 pag. 104</p> <p>Thik Spring 2</p>  <p>2-9 anni 23x70h87cm</p>	<p>art. OI1407 pag. 105</p> <p>Think Spring 3</p>  <p>2-9 anni 23x70h87cm</p>	<p>art. OI1405 pag. 105</p> <p>Think Spring 4</p>  <p>2-9 anni 23x70h87cm</p>	<p>art. OI1409 pag. 105</p> <p>Think Spring 5</p>  <p>2-9 anni 23x70h87cm</p>	<p>art. OI1430 pag. 106</p> <p>Parrot</p>  <p>2-8 anni 90x25h88cm</p>
<p>art. OI2601 pag. 107</p> <p>Spirit</p>  <p>2-8 anni 25x88h95cm</p>	<p>art. OI2602 pag. 107</p> <p>Vespino</p>  <p>2-8 anni 23x80h85cm</p>	<p>art. OI2603 pag. 106</p> <p>Fiuto</p>  <p>2-8 anni 23x94h89cm</p>	<p>art. OI2604 pag. 106</p> <p>Aladar</p>  <p>2-8 anni 23x88h88cm</p>	<p>art. OI2614 pag. 107</p> <p>Emil</p>  <p>2-8 anni 23x90h90cm</p>	<p>art. OI1435 pag. 107</p> <p>Rocco</p>  <p>2-8 anni 23x82h90cm</p>
<p>art. OI1115 pag. 104</p> <p>Cavaluccio Natura</p>  <p>2-6 anni 83x40h94cm</p>	<p>art. OI1116 pag. 104</p> <p>Bambi Natura</p>  <p>2-6 anni 83x40h94cm</p>	<p>art. OI1410 pag. 109</p> <p>Fantasy Spring 1</p>  <p>2-8 anni 73x49h92cm</p>	<p>art. OI1412 pag. 109</p> <p>Fantasy Spring 2</p>  <p>2-8 anni 73x49h92cm</p>	<p>art. OI1414 pag. 109</p> <p>Fantasy Spring 3</p>  <p>2-8 anni 73x49h92cm</p>	<p>art. OI1416 pag. 109</p> <p>Fantasy Spring 4</p>  <p>2-8 anni 73x49h92cm</p>

art. O11419 pag. 109
Fantasy Spring 5

2-8 anni 73x49h92cm

art. O12623 pag. 110
Elefy

2-6 anni 44x70h91cm

art. O12621 pag. 110
Moby

2-6 anni 44x77h91cm

art. O12622 pag. 110
Cinquecento

2-6 anni 44x81h93cm

art. O11420 pag. 108
Multi Spring 1

2-8 anni 84x73h92cm

art. O11422 pag. 108
Multi Spring 2

2-8 anni 84x73h92cm

art. O11424 pag. 108
Multi Spring 3

2-8 anni 84x73h92cm

art. O11426 pag. 108
Multi Spring 4

2-8 anni 84x73h92cm

art. O11429 pag. 108
Multi Spring 5

2-8 anni 84x73h92cm

art. O12633 pag. 111
Elefy 3 Posti

2-8 anni 84x77h92cm

art. O12631 pag. 111
Moby - 3 posti

2-6 anni 84x77h92cm

art. O12632 pag. 111
Cinquecento - 3 posti

2-6 anni 84x77h92cm

art. O11440 pag. 113
Rocco Doppio

2-8 anni 125x23h92cm

art. O17124 pag. 229
Fragola Multi Spring

1-6 anni 84x77h92cm

art. O17113 pag. 229
Banana Spring

2-8 anni 125x23h82cm

Equilibrio e Fantasia

Balancing and Fantasy

<p>art. 011222 pag. 87</p> <p>Piramide</p>  <p>3-11 anni 100x100hmax100cm</p>	<p>art. 011060 pag. 117</p> <p>Asse di Equilibrio</p>  <p>da 3 anni 14x300h35cm</p>	<p>art. 011212 pag. 117</p> <p>Asse su Molle</p>  <p>da 3 anni 20x300h40cm</p>	<p>art. 011065 pag. 117</p> <p>Percorso di Equilibrio su Asse</p>  <p>da 3 anni Lunghezza 900cm</p>	<p>art. 011070 pag. 116</p> <p>percorso di Equilibrio su Tronchi</p>  <p>da 3 anni 75x375h35cm</p>	<p>art. 011107 pag. 116</p> <p>Jumpy</p>  <p>3-11 anni Ø54h43cm</p>
<p>art. 011123 pag. 116</p> <p>Percorso Jumpy</p>  <p>3-11 anni 455x172h43cm</p>	<p>art. 015148 pag. 168</p> <p>Ponte Oscillante Young</p>  <p>2-12 anni 270x114h110cm</p>	<p>art. 016021 pag. 117</p> <p>Ponticello Mobile Fruts</p>  <p>3-8 anni 40x205h36cm</p>	<p>art. 011215 pag. 126</p> <p>Topolino</p>  <p>3-8 anni 35x80h50cm</p>	<p>art. 011213 pag. 126</p> <p>Porcellino</p>  <p>2-8 anni 60x120hmax65cm</p>	<p>art. 011211-L pag. 126</p> <p>Chiocciolona</p>  <p>da 2 anni 192x36h59cm</p>
<p>art. 011203 pag. 125</p> <p>Trattore solo Motrice</p>  <p>2-11 anni 158x130h112cm</p>	<p>art. 011202 pag. 125</p> <p>Trattore</p>  <p>2-11 anni 130x360h112cm</p>	<p>art. 011201 pag. 127</p> <p>Treno Natura</p>  <p>3-8 anni 90x570h167cm</p>	<p>art. 011220 pag. 118</p> <p>Arena dei bambini</p>  <p>3-14 anni 500x272h155cm</p>		

art. 015023 pag. 160
Lavagna per l'Esterno



2-14 anni 140x9h120cm

art. 015024 pag. 160
Pannello Figurativo



2-14 anni 115x9h120cm

art. 015025 pag. 160
Pannello Tris



2-14 anni 115x9h120cm

art. 015022 pag. 161
Specchio Magico



2 anni in sù 110x14h120cm

art. 015029 pag. 161
Gioco dell'Euro



2 anni in sù 114x9h120cm

art. 015142 pag. 198
Galeone



3-11 anni 540x460h330cm

art. 015014 pag. 163
Locomotiva Young



2-11 anni 145x365h200cm

art. 015046 pag. 166
Stegosaurus



2-11 anni 145x365h200cm

art. 015048 pag. 166
Stegosaurus Poly



3-11 anni 522x462h280cm

art. 015051 pag. 167
Balena



3-11 anni 515x452h260cm

art. 015143 pag. 198
Goletta



3-14 anni 770x1240h430cm

art. 015044 pag. 199
Veliero



3-14 anni 1030x1700hmax760cm

art. 017036 pag. 214
Angolo Rè Artù



1-6 anni 146x146h120cm

art. 017038 pag. 216
Ponticello Excalibur



1-3 anni 64 x166h120cm

Tunnel, Labirinti e Piste

Tunnel, Mazes and Tracks

<p>art. 011190 pag. 127</p> <p>Tunnel Classic</p>  <p>2-11 anni 113x245h95cm</p>	<p>art. 015011 pag. 157</p> <p>Tunnel Young 200</p>  <p>3-11 anni 87x200h84cm</p>	<p>art. 015041 pag. 157</p> <p>Tunnel Pumbaa</p>  <p>2-11 anni 119x199h139cm</p>	<p>art. 017037 pag. 215</p> <p>Tunnel Merlino</p>  <p>1-6 anni 98x127h103cm</p>	<p>art. 015031 pag. 162</p> <p>Labirinto Young Piccolo</p>  <p>da 2 anni 325x325h120cm</p>	<p>art. 015032 pag. 162</p> <p>Labirinto Young Medio</p>  <p>da 2 anni 325x430h120cm</p>
<p>art. 015033 pag. 162</p> <p>Labirinto Young Grande</p>  <p>da 2 anni 430x530h120cm</p>	<p>art. 016087 pag. 154</p> <p>Pista Baby Sprint</p>  <p>2-8 anni 2500 cm (Lunghezza totale percorso)</p>	<p>art. 016088 pag. 155</p> <p>Pista Baby Sprint Maxi</p>  <p>3-9 anni 4000 cm(Lunghezza totale percorso)</p>	<p>art. 016093 pag. 155</p> <p>Vigile</p>  <p>2-8 anni Ø16xh113cm</p>	<p>art. 016094 pag. 154</p> <p>Stazione Pompa di Benzina</p>  <p>2-8 anni 14x270h164cm</p>	

Sabbia e Acqua

Sand and Water

<p>art. 011031 pag. 119</p> <p>Sabbiera Semplice 2x2</p>  <p>2 anni in sù 200x200h23cm</p>	<p>art. 011030 pag. 119</p> <p>Sabbiera Semplice 3x3</p>  <p>2 anni in sù 300x300h23cm</p>	<p>art. 011026 pag. 120</p> <p>Sabbiera Coperchio Mobile 2x2</p>  <p>2 anni in sù 200 x 200 H 48 (cop. chiuso)</p>	<p>art. 011025 pag. 120</p> <p>Sabbiera Coperchio Mobile 2,4x4</p>  <p>2 anni in sù 240 x 423 H 48 (cop. chiuso)</p>	<p>art. 011043 pag. 121</p> <p>Tavolo di Manipolazione</p>  <p>2-8 anni 180x75h40cm</p>	<p>art. 011042 pag. 121</p> <p>Multigioco per Acqua e Sabbia</p>  <p>2-11 anni 236x237hmax70cm</p>
<p>art. 011044 pag. 124</p> <p>Vasca per Acqua e Sabbia</p>  <p>2-11 anni 92x123h50cm</p>	<p>art. 016017 pag. 124</p> <p>Sabbiera Fruts</p>  <p>2-8 anni 77x181h19cm</p>	<p>art. 017115 pag. 231</p> <p>Sabbiera Coccinella</p>  <p>1-10 anni 234x220h52cm</p>	<p>art. 017116 pag. 230</p> <p>Sabbiera Grillo</p>  <p>1-10 anni 234x419h58cm</p>	<p>art. 011248 pag. 123</p> <p>Vasca per orti didattici baby</p>  <p>2 anni in sù 165x80cmh65cm</p>	<p>art. 011245 pag. 123</p> <p>Garden Boy 3</p>  <p>2 anni in sù Ø60h82cm</p>
<p>art. 011246 pag. 123</p> <p>Garden Boy flower</p>  <p>2 anni in sù Ø60h37cm</p>	<p>art. 011242 pag. 123</p> <p>Fontana Garden Boy</p>  <p>2 anni in sù Ø60h37cm</p>	<p>art. 011199 pag. 259</p> <p>Fontana Semplice in Legno</p>  <p>30x15h95cm</p>			

Orti didattici

Educational gardens

<p>art. 011238 pag. 123</p> <p>Recinto basso garden boy</p>  <p>14x151h63,5cm</p>	<p>art. 011231-C pag. 123</p> <p>Brucone Color</p>  <p>da 2 anni 300x30h50cm</p>	<p>art. 071607-S pag. 123</p> <p>Vasca per orti didattici 2</p>  <p>96x188h28cm</p>	<p>art. 011244 pag. 123</p> <p>Garden Boy 2</p>  <p>da 2 anni 64x106h107cm</p>	<p>art. 154110 pag. 123</p> <p>Bacheca Tipo 10</p>  <p>1x20h250cm</p>	<p>art. 011248 pag. 123</p> <p>Vasca per orti didattici baby</p>  <p>da 2 anni 165x80cmh65cm</p>
<p>art. 011243 pag. 123</p> <p>Palo recinto Garden Boy</p>  <p>0x63,5h110cm</p>	<p>art. 011241-C pag. 123</p> <p>Rana color</p>  <p>da 2 anni 35x60h59cm</p>	<p>art. 011019 pag. 123</p> <p>Rifugio natura</p>  <p>2-11 anni 192x212h204cm</p>	<p>art. 011240 pag. 123</p> <p>Composter Garden Boy</p>  <p>67x122,5h59cm</p>	<p>art. 011236 pag. 123</p> <p>Fioriera Garden Boy</p>  <p>Ø67h35cm</p>	<p>art. 011246 pag. 123</p> <p>Garden Boy Flower</p>  <p>da 2 anni Ø60h37cm</p>
<p>art. 011233 pag. 123</p> <p>Coccinella</p>  <p>da 2 anni 55x130H59cm</p>	<p>art. 011014 pag. 123</p> <p>Baby Tent</p>  <p>2-11 anni 200x200h163cm</p>	<p>art. 011237 pag. 123</p> <p>Recinto alto garden Boy</p>  <p>16x252h83,5cm</p>	<p>art. 011242 pag. 123</p> <p>Fontana garden Boy</p>  <p>48x86h137cm</p>	<p>art. 011211-L pag. 123</p> <p>Chiocciolona</p>  <p>192x36h59cm</p>	

Scivoli

Slides

art. 011139 pag. 128
Scivolo da Pendio 620 cm



3-14 anni 64x620cm

art. 015091 pag. 158
Scivolo Nube 100



2-9 anni 68x230h180cm

art. 015092 pag. 158
Scivolo Nube 150



3-11 anni 70x310h230cm

art. 015094 pag. 159
Scivolo Aria



2-11 anni 78x396h225cm

art. 016023 pag. 152
Scivolo Dumbo



3-9 anni 86x322h168cm

art. 016018 pag. 152
Scivolo Riccio



3-9 anni 86x322h168cm

art. 016026 pag. 153
Scivolo Fungo



3-9 anni 86x322h175cm

art. 016037 pag. 153
Scivolo Polpo



3-9 anni 86x322h169cm

art. 016028 pag. 151
Scivolo Dino



3-9 anni 86x322h269cm

art. 016039 pag. 150
Scivolo Giraffa



3-9 anni 86x322h279cm

art. 017040 pag. 217
Torre Robin Hood



1-6 anni 64x193h145cm

art. 017048 pag. 218
Torre Parsifal - Levatoio



1-6 anni 82x262h145cm

art. 017053 pag. 217
Torre Lancillotto - Scala



1-6 anni 158x174h145cm

art. 017151 pag. 232
Torre Melo



1-6 anni 82x240h140cm

Torri

Towers

<p>art. 015560 pag. 176</p> <p>Torretta Scoiattolo 100</p>  <p>2-8 anni 331x78h178cm</p>	<p>art. 015565 pag. 176</p> <p>Torretta Scoiattolo 150</p>  <p>2-12 anni 446x78h228cm</p>	<p>art. 015570 pag. 177</p> <p>Torre Lontra 150</p>  <p>2-12 anni 482x152h398cm</p>	<p>art. 015575 pag. 179</p> <p>Torre Volpe</p>  <p>3-12 anni 425x195h398cm</p>	<p>art. 015580 pag. 179</p> <p>Torre Lince</p>  <p>3-12 anni 492x188h398cm</p>	<p>art. 015585 pag. 179</p> <p>Torre Lupo</p>  <p>3-12 anni 473x152h398cm</p>
<p>art. 015590 pag. 177</p> <p>Torre Lontra 200</p>  <p>2-12 anni 597x152h458cm</p>	<p>art. 015595 pag. 178</p> <p>Torre Lontra Spyr</p>  <p>2-12 anni 506x152h458cm</p>	<p>art. 015600 pag. 180</p> <p>Torre Daino</p>  <p>2-12 anni 482x505h398cm</p>	<p>art. 015605 pag. 180</p> <p>Torre Cervo</p>  <p>2-12 anni 482x368h398cm</p>	<p>art. 015610 pag. 181</p> <p>Torre Renna</p>  <p>2-12 anni 721x482h398cm</p>	<p>art. 015620 pag. 182</p> <p>Torre Martora</p>  <p>2-9 anni 260x310h348cm</p>
<p>art. 015625 pag. 183</p> <p>Torre Marmotta</p>  <p>2-9 anni 663x261h348cm</p>	<p>art. 015630 pag. 183</p> <p>Torre Faina</p>  <p>2-9 anni 525x260h348cm</p>	<p>art. 015640 pag. 184</p> <p>Torre Puma</p>  <p>3-12 anni 420x351h228cm</p>	<p>art. 015645 pag. 185</p> <p>Torre Castoro</p>  <p>3-12 anni 351x284h278cm</p>	<p>art. 017050 pag. 218</p> <p>Torre Parsifal</p>  <p>1-6 anni 82x240h145cm</p>	<p>art. 017151 pag. 232</p> <p>Torre Melo - Scala Gradini</p>  <p>1-6 anni 240x82h140cm</p>

Foglie

Foglie

art. 015500 pag. 170
Torre Scricciolo



1-9 anni 310x212h320cm

art. 015505 pag. 170
Torre Cincia



2-12 anni 150x355h240cm

art. 015510 pag. 171
Torre Gazza



3-12 anni 360x240h345cm

art. 015535 pag. 173
Castello Airone



3-12 anni 515x460h345cm

art. 015540 pag. 174
Castello Aquila



3-12 anni 515x460h345cm

art. 015545 pag. 175
Castello Grifone



3-12 anni 520x880h400cm

Castelli

Castles

art. 015635 pag. 186
Castello Alice



3-12 anni 671x250h398cm

art. 015650 pag. 186
Castello Oasi



2-12 anni 603x378h398cm

art. 015660 pag. 187
Castello Pampa



3-12 anni 513x378h390cm

art. 015670 pag. 188
Castello Selva



3-12 anni 598x378h398cm

art. 015680 pag. 188
Castello Pineta



2-12 anni 588x378h398cm

art. 015685 pag. 189
Castello Bosco



2-12 anni 588x593h398cm

art. 015690 pag. 190
Castello Foresta



2-12 anni 813x721h398cm

art. 015700 pag. 191
Castello Tundra



3-12 anni 625x813h398cm

art. 015710 pag. 192
Castello Prateria



2-12 anni 971x883h398cm

art. 015720 pag. 193
Castello Savana



2-12 anni 1030x1033h398cm

art. 015730 pag. 194
Castello Dolomiti



3-14 anni 689x686h470cm

art. 015735 pag. 195
Castello Alpi



3-14 anni 631x749h470cm

art. 015750 pag. 196
Castello Himalaya



3-14 anni 1278x1519h470cm

art. 015755 pag. 197
Castello Hiamalaya Maxi



3-14 anni 1832x1769h470cm

art. 017062 pag. 221
Castello Saladino



1-6 anni 176x441h145cm

art. 017160 pag. 233
Castello Melo - Scala Pioli



1-6 anni 435x90h140cm

I love wood pag. 233



















Castelli Colore

Colour Castles











NIDI - Linea Camelot

NURSERY - Camelot Line

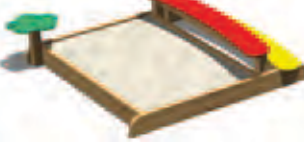
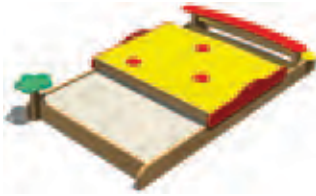
<p>art. 017036 pag. 214</p> <p>Angolo Re Artù</p>  <p>1-6 anni 146x146h120cm</p>	<p>art. 017037 pag. 215</p> <p>Tunnel Merlino</p>  <p>1-6 anni 98x127h103cm</p>	<p>art. 017038 pag. 216</p> <p>Ponticello Excalibur</p>  <p>1-3 anni 64x166h120cm</p>	<p>art. 017040 pag. 217</p> <p>Torre Robin Hood</p>  <p>1-6 anni 64x193h145cm</p>	<p>art. 017048 pag. 218</p> <p>Torre Parsifal - Levatoio</p>  <p>1-6 anni 82x262h145cm</p>	<p>art. 017050 pag. 218</p> <p>Torre Parsifal - Scala</p>  <p>1-6 anni 82x240h145cm</p>
<p>art. 017051 pag. 218</p> <p>Torre Parsifal - Rampa</p>  <p>1-6 anni 82x262h145cm</p>	<p>art. 017052 pag. 219</p> <p>Torre Lancillotto - Levatoio</p>  <p>1-6 anni 181x174h145cm</p>	<p>art. 017053 pag. 219</p> <p>Torre Lancillotto - Scala</p>  <p>1-6 anni 158x174h145cm</p>	<p>art. 017054 pag. 219</p> <p>Torre Lancillotto - Rampa</p>  <p>1-6 anni 155x174h145cm</p>	<p>art. 017060 pag. 220</p> <p>Castello Graal</p>  <p>1-6 anni 82x445h145cm</p>	<p>art. 017061 pag. 220</p> <p>Castello Sherwood</p>  <p>1-6 anni 82x447h145cm</p>
<p>art. 017063 pag. 220</p> <p>Castello Nottingham</p>  <p>1-6 anni 174x437h145cm</p>	<p>art. 017062 pag. 221</p> <p>Castello Saladino</p>  <p>1-6 anni 176x441h145cm</p>	<p>art. 017065 pag. 222</p> <p>Castello Templari</p>  <p>2-9 anni 576x420h323cm</p>	<p>art. 017066 pag. 223</p> <p>Castello Sir Bis</p>  <p>1-6 anni 390x386h145cm</p>	<p>I love wood pag. 211</p> 	

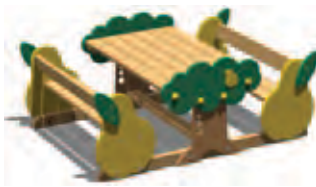

NIDI - Linea Tuttifrutti

NURSERY - Tuttifrutti Line

<p>art. 017101 pag. 226</p> <p>Primipassi</p>  <p>1-3 anni 60x40h60cm</p>	<p>art. 017102 pag. 226</p> <p>Primipassi Doppio</p>  <p>1-3 anni 193x41h87cm</p>	<p>art. 017113 pag. 229</p> <p>Banana Spring</p>  <p>2-8 anni 125x23h82cm</p>	<p>art. 017114 pag. 229</p> <p>Fragola Spring</p>  <p>1-6 anni 46x72h83cm</p>	<p>art. 017201 pag. 228</p> <p>Banana Climb</p>  <p>2-6 anni 85x85h55/69cm</p>	<p>art. 017205 pag. 228</p> <p>Mandarino Climb</p>  <p>1-3 anni 80x82h65cm</p>
<p>art. 017115 pag. 231</p> <p>Sabbiera Coccinella</p>  <p>1-10 anni 234x220h52cm</p>	<p>art. 017116 pag. 230</p> <p>Sabbiera Grillo</p>  <p>1-10 anni 234x419h58cm</p>	<p>art. 017151 pag. 232</p> <p>Torre Melo - Scala Gradini</p>  <p>1-6 anni 240x82h140cm</p>	<p>art. 017160 pag. 233</p> <p>Castello Melo - Scala Pioli</p>  <p>1-6 anni 435x90h140cm</p>	<p>art. 017161 pag. 233</p> <p>Castello Melo - Scala Gradini</p>  <p>1-6 anni 470x90h140cm</p>	<p>art. 017103 pag. 227</p> <p>Lavagna</p>  <p>1-6 anni 97x45h110cm</p>
<p>art. 017110 pag. 240</p> <p>Gruppo Mela</p>  <p>1-3 anni 132x94h24/44cm</p>	<p>art. 017111 pag. 241</p> <p>Gruppo Pera</p>  <p>1-3 anni 132x94h24/44cm</p>	<p>art. 017138 pag. 242</p> <p>Tavolo Arancia</p>  <p>3-6 anni 60x125h54cm</p>	<p>art. 017140 pag. 244</p> <p>Cestino Pera</p>  <p>45x65h85cm</p>	<p>I love wood pag. 219</p> 	

Impianti Ginnici

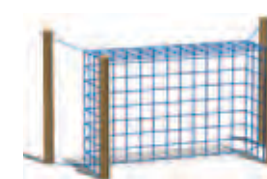
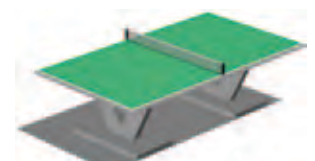
Sport&Gym

<p>art. O11080 pag. 130</p> <p>Sbarre a Tripla Altezza</p>  <p>3 anni in sù 14x342h180cm</p>	<p>art. O11225 pag. 90</p> <p>Dolomiti Climb</p>  <p>4 anni in sù Ø290h250cm</p>	<p>art. O11160 pag. 93</p> <p>Combigny</p>  <p>3-14 152x300h237cm</p>	<p>art. O15006 pag. 158</p> <p>Palestra Esagonale Young</p>  <p>3-11 anni Ø230xh209cm</p>	<p>art. O15019 pag. 158</p> <p>Palestra Esagonale Young Climb</p>  <p>3-11 anni 222x192h209cm</p>	<p>art. O11168 pag. 129</p> <p>Porta Calcio per Aree Incustodite</p>  <p>3 anni in sù 300x250h240cm</p>
<p>art. O11176 pag. 129</p> <p>Porte da Calciotto Regolamentari</p>  <p>3 anni in sù 300x200cm</p>	<p>art. O11068 pag. 129</p> <p>Tavolo Ping Pong da Esterno</p>  <p>Regolamentari</p>	<p>art. O11166 pag. 128</p> <p>Canestro Semplice</p>  <p>5 anni in sù 45x67h220cm</p>	<p>art. O11164 pag. 128</p> <p>Impianto Basket Olimpionico</p>  <p>5 anni in sù</p>	<p>pag. 130 / 131</p> <p>Vita Parcours (Percorso Fitness)</p>  <p>da 4 anni</p>	<p>art. O11218 pag. 91</p> <p>Boulder Wall</p>  <p>da 6 anni 650x200h280cm</p>
<p>art. O11317 pag. 92</p> <p>Vita Park Station</p>  <p>da 4 anni 945x1064xh238cm</p>	<p>art. O12091 pag. 129</p> <p>Tappeto elastico piccolo</p>  <p>da 3 anni 175x150cm</p>	<p>art. 202051 pag. 134</p> <p>Easy Adventure 5</p>  <p>da 8 anni Lungh.percorso 22M</p>	<p>art. 202050 pag. 134</p> <p>Easy Adventure 10</p>  <p>da 8 anni Lungh.percorso 45M</p>	<p>art. O19200 pag. 140 in poi</p> <p>Argentovivo Full</p>  <p>da 5 anni 26 Mq (min)</p>	

Arredo Scuole

School Furniture

<p>art. 016105 pag. 245</p> <p>Gruppo d'Arredo Fruts</p>  <p>2-8 anni 130x120h50cm</p>	<p>art. 016100 pag. 245</p> <p>Panca Fruts senza Schienale</p>  <p>2-8 anni 29x120h27cm</p>	<p>art. 016101 pag. 245</p> <p>Panca Fruts con Schienale</p>  <p>2-8 anni 29x120h27/44cm</p>	<p>art. 016102 pag. 245</p> <p>Tavolo Fruts</p>  <p>2-8 anni 57x120h50cm</p>	<p>art. 011170 pag. 246</p> <p>Set Scuola Materna</p>  <p>3-11 anni 150x161h70cm</p>	<p>art. 011173 pag. 246</p> <p>Tavolo Scuola Materna</p>  <p>3-11 anni 150x60h60cm</p>
<p>art. 011175 pag. 246</p> <p>Panca Scuola Materna con Schienale</p>  <p>3-11 anni 150x55h70cm</p>	<p>art. 011180 pag. 246</p> <p>Panca Scuola Materna senza Schienale</p>  <p>3-11 anni 150x45h40cm</p>	<p>art. 071350 pag. 247</p> <p>Pic Nic Junior</p>  <p>2-8 anni 130x120h55cm</p>	<p>art. 017107 pag. 242</p> <p>Panca Arancia</p>  <p>3-6 anni 38x125h30cm</p>	<p>art. 017138 pag. 242</p> <p>Tavolo Arancia</p>  <p>3-6 anni 60x125h54cm</p>	<p>art. 017112 pag. 242</p> <p>Gruppo Arancia</p>  <p>3-6 anni 140x125h30/54cm</p>
<p>art. 017118 pag. 243</p> <p>Gruppo Arredo Frutta</p>  <p>1-10 anni 145x150h44/54cm</p>	<p>art. 017119 pag. 243</p> <p>Seduta Mela</p>  <p>3-11 anni Ø20h24/30cm</p>	<p>art. 017120 pag. 243</p> <p>Tavolino Pera</p>  <p>1-10 anni Ø60h44/54cm</p>	<p>art. 017140 pag. 244</p> <p>Cestino Pera</p>  <p>45x65h85cm</p>	<p>art. 017145 pag. 244</p> <p>Banana Box</p>  <p>80x125h80cm</p>	<p>art. 017103 pag. 227</p> <p>Lavagna</p>  <p>1-6 anni 97x45h110cm</p>



LINEA TREES

TREES LINE

Strutture ludiche, esclusive ed uniche al mondo dove l'albero, elemento principale ed insostituibile della produzione di Legnolandia, diventa emblematico, riconoscibile e familiare: il fulcro del parco giochi.

Trees caratterizzano non solo parchi ed aree verdi, ma anche spazi urbani che vogliono vestirsi di colori e forme più amati: quelli della natura.

Playground equipments, exclusive and unique in the world. The tree as the main element becomes emblematic and irreplaceable in Legnolandia's production: it is the core of the playground.

Trees do not only characterize parks and green areas, but also urban spaces that want to dress in the most popular colours and shapes: the colours of nature.



CONNECTED TO THE NATURE

TREES

Legnolandia fornisce gratuitamente la progettazione, senza impegno, di un "TREE PARK" considerando spazi e disponibilità economica.

Basta scrivere a: info@legnolandia.com

Legnolandia provides free design, without obligation, a "TREE PARK" considering space and budget.

Just write to: info@legnolandia.com



Legnolandia consiglia l'utilizzo di superfici anti-trauma con materiali naturali: prato, ghiaia, sabbia, cippato, corteccia. Sono economiche, sicure, divertenti e non feriscono il pianeta.

Legnolandia recommends the use of anti-shock surfaces made of natural materials: grass, gravel, sand, wood chips, bark. They are economic, safe, fun and do not hurt the planet.



LEGNOLANDIA

DA UN TRONCO DALLE RADICI PROFONDE CRESCONO I RAMI FONDAMENTALI DELLA NOSTRA FILOSOFIA PRODUTTIVA.
A TREE WITH DEEP ROOTS SUPPORTS THE BRANCHES ON WHICH WE BASE OUR PRODUCTION PHILOSOPHY.

Sicurezza:
Certificati TÜV.
Assicurazione R.C.
Calcoli statici.

Safety and durability:
TÜV certificates.
Liability insurance.
Static calculations.



Salvaguardia ambientale:

Certificati ISO 14001 - PEFC - FSC

Environmental safeguard:
ISO 14001 - PEFC - FSC certificates.



Riduzione della CO₂ grazie a:

Materia prima a "Km. zero".
Energia da fonti rinnovabili.
Solo materiali eco-compatibili.

CO₂ reduction through:
Local raw material.
Energy from renewable sources.
Only eco-friendly materials.



Salute ed inclusività:
Progettazione su basi scientifiche.
Giochi inclusivi adatti a tutte le abilità.

Health and inclusiveness:
Design based on scientific knowledge.
Inclusive playgrounds suitable for any kind of ability.



Servizio e Garanzie:

Progettazione gratuita aree attrezzate.
Manutenzione minima.
Assistenza continua.
Garanzia fino a 20 anni.

Service and Warranty:
Planning and design free of charge.
Continuous assistance.
Minimal maintenance.
Warranty up to 20 years.

LEGNOLANDIA

Dal 1830 lavoriamo il legno dei nostri boschi a "Km. zero"

Since 1830 we work wood from our local forests.

CO2 NO THANKS

sintetizza la filosofia di questo progetto il cui obiettivo è quello di creare parchi gioco capaci di abbattere le emissioni in atmosfera.

CO2 NO THANKS

summarizes the philosophy of this project whose goal it is to create products that reduce emissions.





-102,00
Kg
CO₂

Tree Swing

ART. 011500

↓ 260 x 46 h190 cm

▭ 460 x 630 cm

👤 3-6

HIC 93 cm



-102,00
Kg
CO₂

Tree Swing Secur

ART. 011501

↓ 260 x 46 h190 cm

▭ 460 x 630 cm

👤 1-5

HIC 93 cm



Tree Tower 100-2

ART. 011510

195 x 396 h200 cm

495 x 722 cm

2-5

HIC 100 cm

-568,00
Kg
CO₂



Tree Tower 100-3

ART. 011511

195 x 379 h200 cm

495 x 702 cm

2-5

HIC 100 cm

-568,00
Kg
CO₂



-454,00
Kg
CO₂

Tree Tower 80-2

ART. 011505

195 x 387 h161 cm

495 x 725 cm

2-5

HIC 80 cm

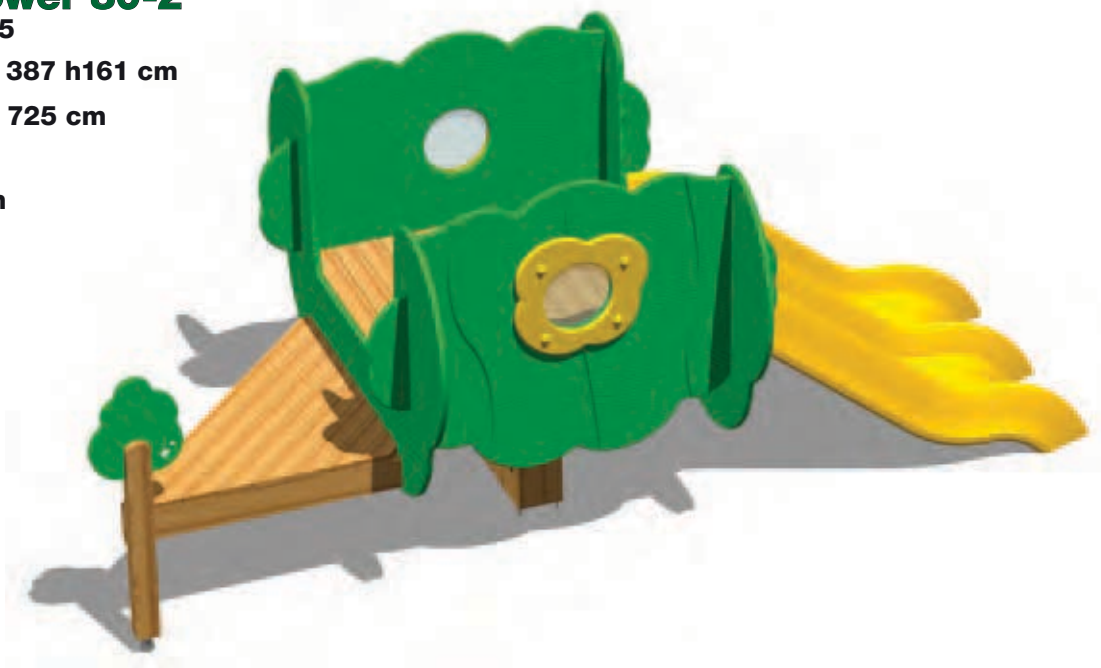

-953,00
Kg
CO₂

Tree Castle 1

ART. 011572

195 x 816 h161 cm

495 x 1166 cm

2-5

HIC 80 cm



Articoli inclusivi fruibili da bambini con ogni tipo di abilità.

Inclusive playgrounds accessible to children with any kind of ability.

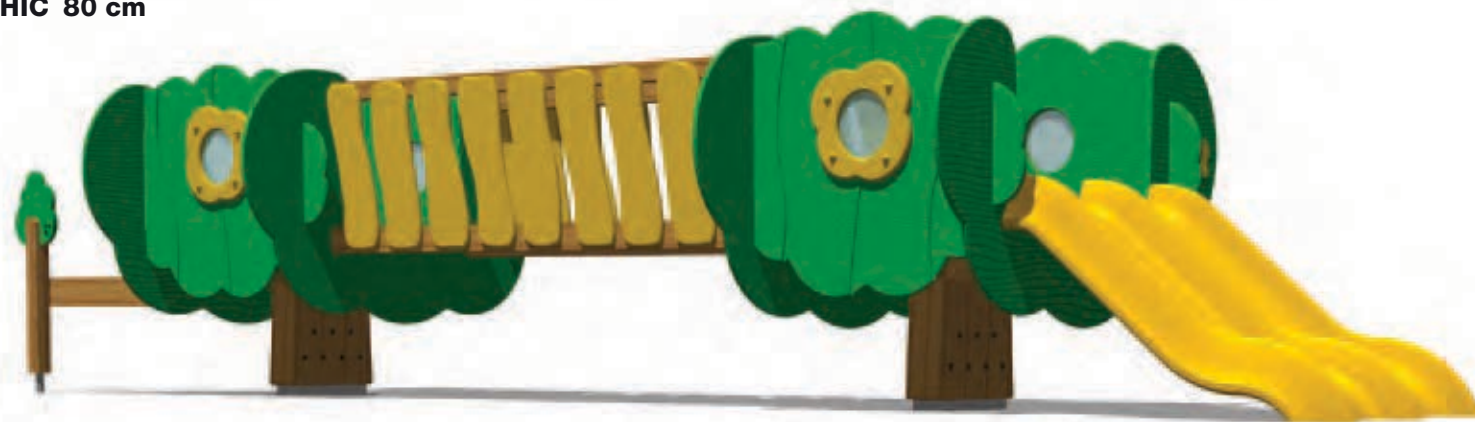



-454,00
Kg
CO₂

Tree Tower 100T-1

ART. 011515

195 x 379 h278cm

495 x 718 cm

2-6

HIC 100 cm



Gioco di abilità.
Ability game.



Tree Tower 150-2

ART. 011530

↕ 195 x 423 h250 cm

▭ 495 x 757 cm

👤 3-12

HIC 150 cm

-641,00
Kg
CO₂



Tree Tower 150-3

ART. 011529

↕ 195 x 522 h250 cm

▭ 495 x 856 cm

👤 3-12

HIC 150 cm

-695,00
Kg
CO₂



Tree Tower 150-4

ART. 011531

↕ 195 x 534 h250 cm

▭ 495 x 884 cm

👤 3-12

HIC 150 cm

-625,00
Kg
CO₂





-782,00
Kg
CO₂

Tree Tower 150T-2

ART. 011545

↕ 195 x 455 h328cm

▭ 495 x 789 cm

👤 3-12

HIC 150 cm



-795,00
Kg
CO₂

Tree Tower 150T-4

ART. 011550

↕ 195 x 495 h328 cm

▭ 495 x 841 cm

👤 3-12

HIC 150 cm



-750,00
Kg
CO₂

Tree Tower 150T-6

ART. 011551

↕ 195 x 527 h328 cm

▭ 495 x 875 cm

👤 3-12

HIC 150 cm





Tree Tower 200-3

ART. 011559

-724,00
Kg
CO₂

↕ 195 x 693 h300 cm

▭ 495 x 978 cm

👤 3-12

HIC 200 cm



Tree Tower 200-2

ART. 011560

-724,00
Kg
CO₂

↕ 195 x 616 h300 cm

▭ 495 x 967 cm

👤 5-12

HIC 200 cm

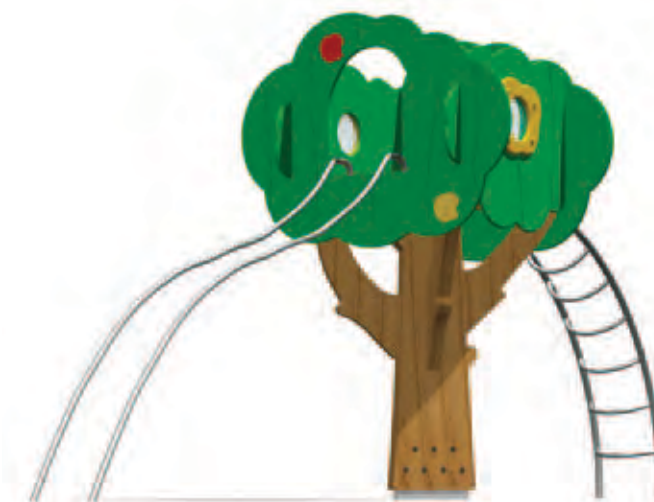



Tree Tower 200T-2

-841,00
Kg
CO₂

ART. 011561

↓ 195 x 616 h378 cm

▭ 495 x 967 cm

👤 5-12

HIC 200 cm



-841,00
Kg
CO₂

Tree Tower 200T-6

ART. 011565

↓ 195 x 643 h378 cm

▭ 495 x 987 cm

👤 3-12

HIC 200 cm





Tree Tower 200T-8

ART. 011564

-841,00
Kg
CO₂

↙ 246 x 500 h378 cm

▭ 591 x 800 cm

👤 3-12

HIC 200 cm

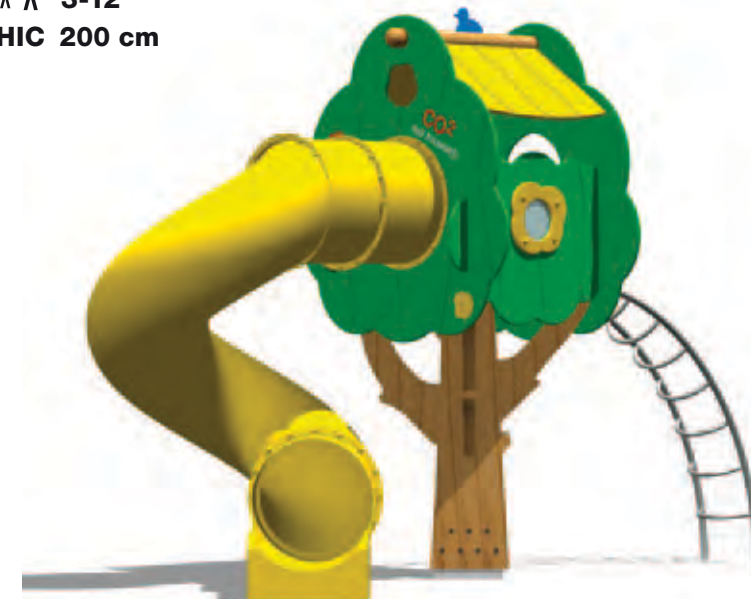

Tree Tower 200T-4

ART. 011563

-841,00
Kg
CO₂

↙ 343 x 473 h378 cm

▭ 662 x 811 cm

👤 3-12

HIC 200 cm





-1456,00
Kg
CO₂

Tree Castle 4

ART. 011573

↕ 405 x 645 h328 cm

▭ 739 x 933 cm

👤 3-12

HIC 100/150 cm

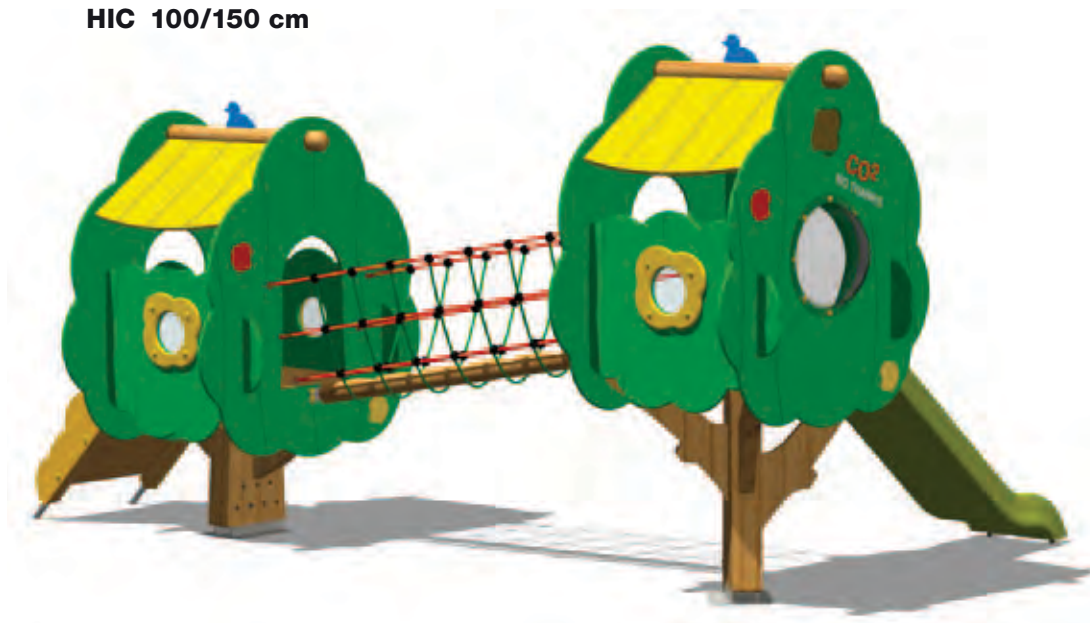



Tree Castle 6

ART. 011574

405 x 631 h328 cm

739 x 927 cm

2-8

HIC 100/150 cm

-1515,00
Kg
CO₂



Gioco di abilità.
Ability game.

Tree Castle 7

ART. 011584

405 x 647 h328 cm

739 x 932 cm

2-8

HIC 100/150 cm

-1620,00
Kg
CO₂



-1682,00
Kg
CO₂

Tree Castle 8

ART. 011575

473 x 707 h378 cm

811 x 1018 cm

3-12

HIC 200 cm

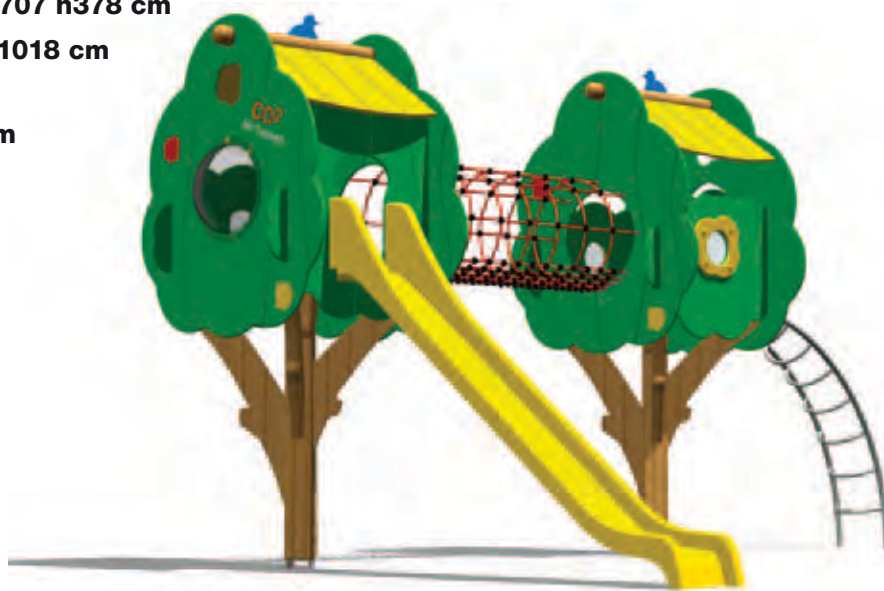

-1682,00
Kg
CO₂

Tree Castle 10

ART. 011577

473 x 750 h378 cm

821 x 1052 cm

3-12

HIC 200 cm







-2452,00
Kg
CO₂

Tree Castle 20

ART. 011580

718 x 993 h378 cm

1018 x 1327 cm

3-12

HIC 150/200 cm

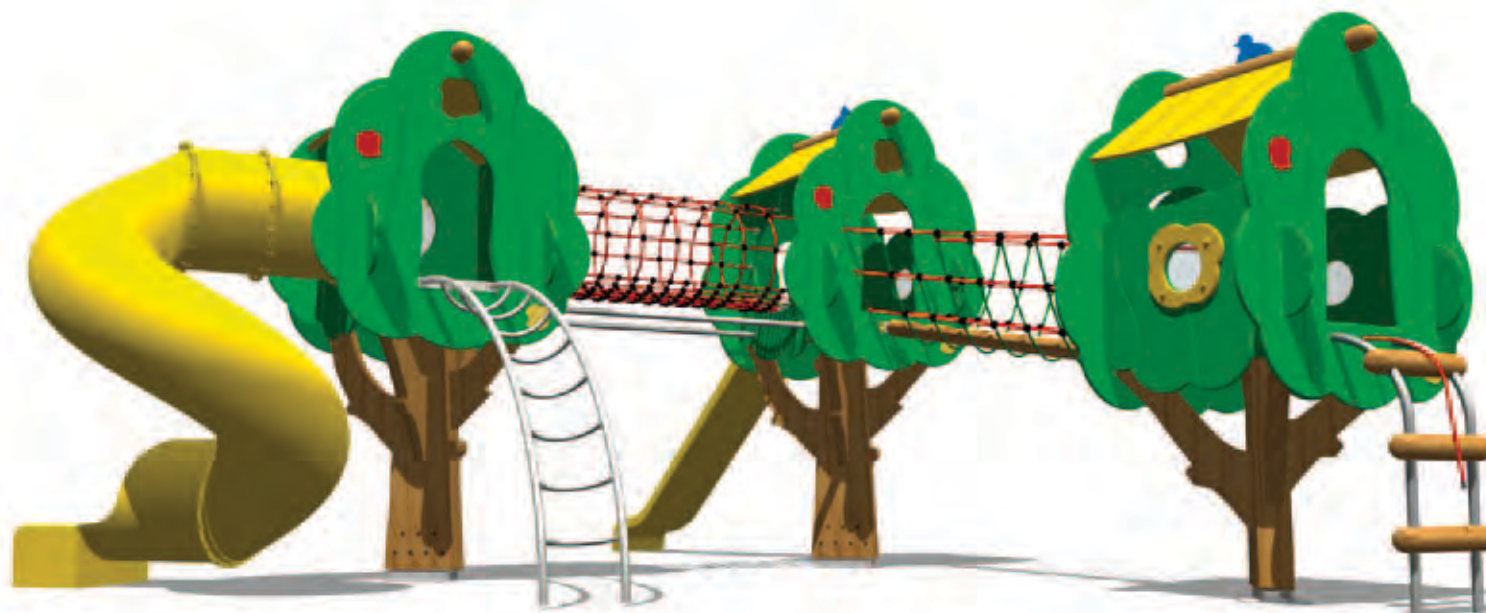



LINEA CLASSIC

CLASSIC LINE

I giochi più classici di Legnolandia studiati non solo per il divertimento, ma anche per la manualità e l'attività fisica di bambini e ragazzi.

Una gamma di giochi completissima, caratterizzata da una robustezza senza paragoni. La struttura portante in legno è realizzata con elementi a sezione cilindrica del diametro di 130 mm, ricavati con la tecnica "fuori cuore lamellare", trattati con l'esclusivo sistema protettivo ExtraCoat. Altri materiali utilizzati sono il polietilene e l'acciaio riciclabili.

Legnolandia's most classical playgrounds, designed not only for fun, but also for the flexibility and physical activity of children and teenagers.

A complete range of playground fixtures, characterized by an unmatched sturdiness. The load-bearing structure formed by 130 mm diameter cylindrical elements, is made of laminated heart-free wood treated with the exclusive ExtraCoat protection. Other materials used are recyclable polyethylene and steel.



-20,56
Kg
CO₂

Altalena Singola Classic

ART. 011045

215 x 300 h 234 cm

765 x 471 cm

3-14



-10,67
Kg
CO₂

Altalena Minny

ART. 011046

14 x 250 h 234 cm

765 x 421 cm

3-11



I seggiolini sono disponibili anche nella versione "a gabbia" per i più piccoli o per utenti diversamente abili. La versione "Minnie" è ideale per spazi ridotti. Perni in acciaio inox.

Safety cradle seats are also available for younger children and disabled people. The "Minnie" version is ideal for narrow areas. Stainless steel fittings.



-21,86
Kg
CO₂

Altalena Doppia Classic

ART. 011050

215 x 400 h 234 cm

765 x 574 cm

3-14

-21,86
Kg
CO₂

Altalena Doppia Mix Classic

ART. 011049

215 x 400 h 234 cm

765 x 574 cm

2-14

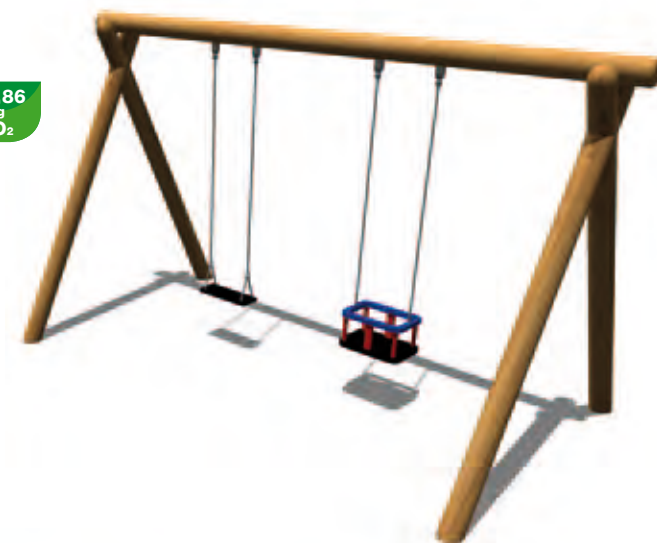

-21,86
Kg
CO₂

Altalena Doppia Secur Classic

ART. 011149

215 x 400 h 234 cm

765 x 574 cm

2-5

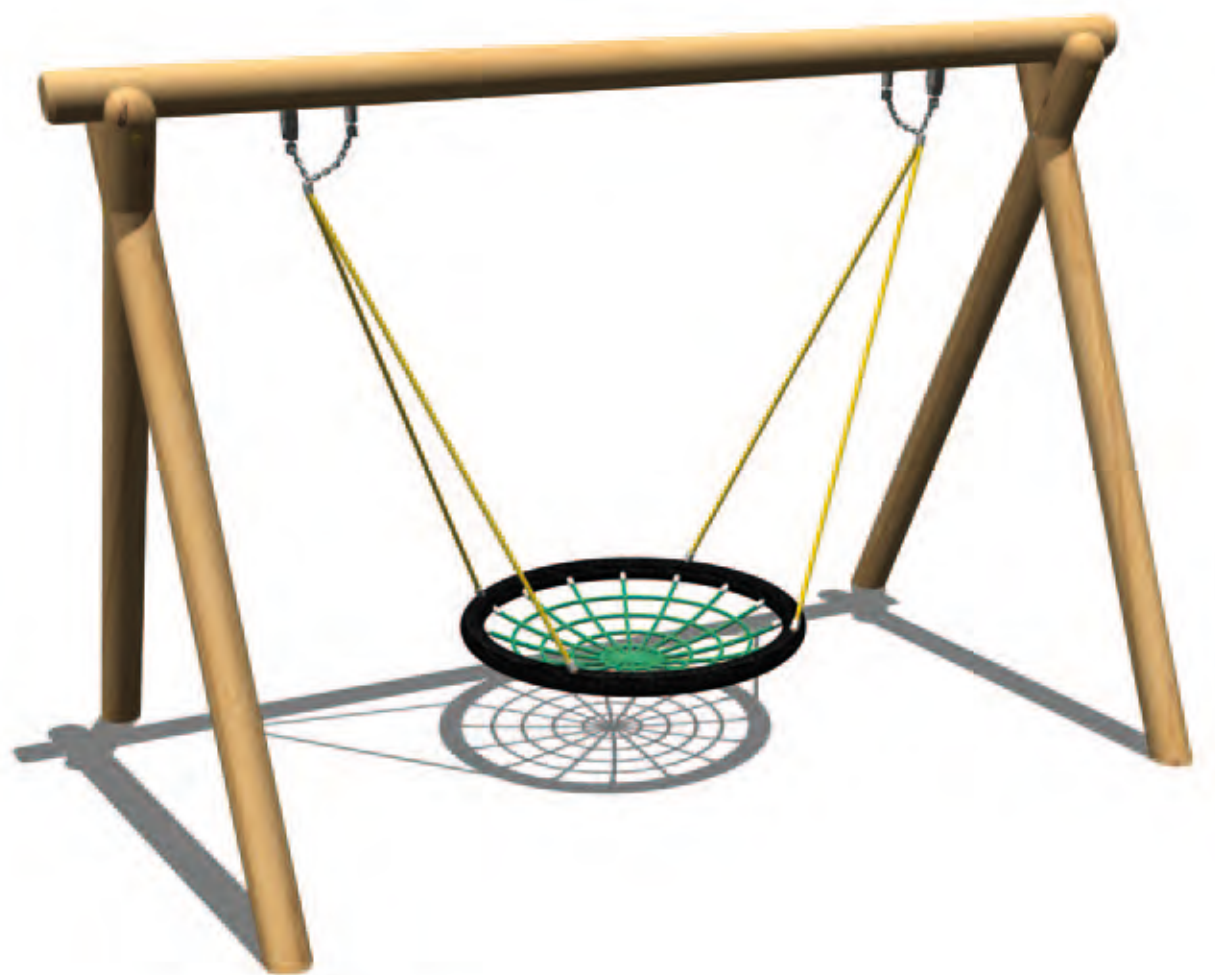

-23,45
Kg
CO₂

Altalena Cestone Classic

ART. 011250

215 x 400 h 234 cm

750 x 548 cm

2-11

Altalena multiposto, particolarmente adatta per l'integrazione al gioco dei più piccoli e dei meno abili. Cestone diametro 120 cm.

Multi-seated swing ideal for involving younger children and disabled people. Basket diameter 120 cm.





-39,39
Kg
CO₂

Altalena Pendolone

ART. 011252

↕ 565 x 249 h 313 cm

▭ 800 x 800 cm

🧑 3-14

Altalena multiposto con struttura in legno lamellare 20x20 cm e grande pneumatico diametro 95 cm. Giunto di rotazione cardanico a doppia sicurezza ed esclusivo dissuasore di salita.

Multi-seated swing with laminated wood structure 20x20 cm and large tyre diameter 95 cm. Double safety universal swivelling joint and exclusive blocked access.



-40,78
Kg
CO₂

Altalena Canapone

ART. 011255

191 x 350 h 242 cm

650 x 491 cm

3-11

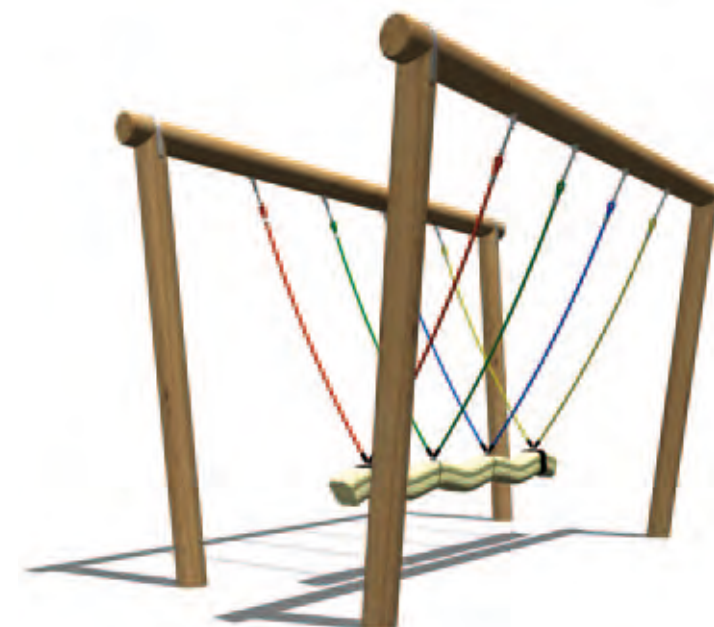

Gioco di gruppo fino a 5-6 utenti.
Montanti con diametro maggiorato di 160 mm.

Multi-child equipment for up to 5-6 users.
Posts with enlarged diameter of 160 mm.



Arrampicata su tronchi, ideale per attività motorie divertenti, facili e sicure.

Log climbing trail, ideal to promote funny, easy and safe motor activities.

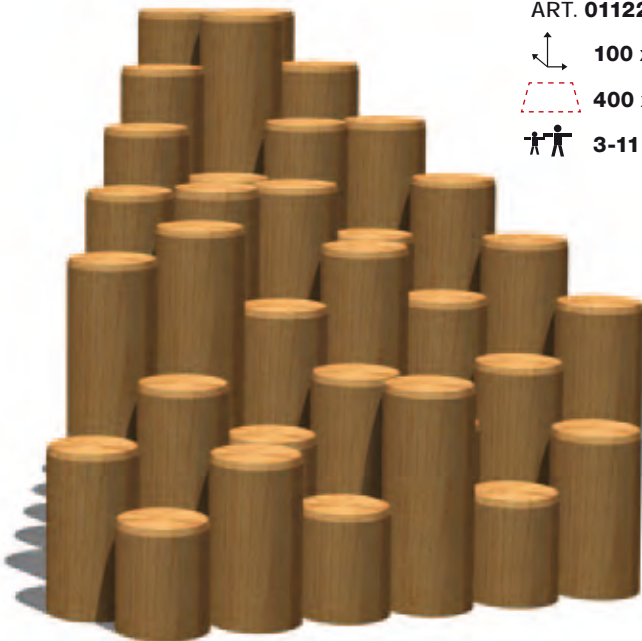

-48,94
Kg
CO₂

Piramide

ART. 011222

100 x 112 h 100 cm

400 x 412 cm

3-11

-5,47
Kg
CO₂

Totem

ART. 011085

16 x 50 h 200 cm

316 x 350 cm

3-14

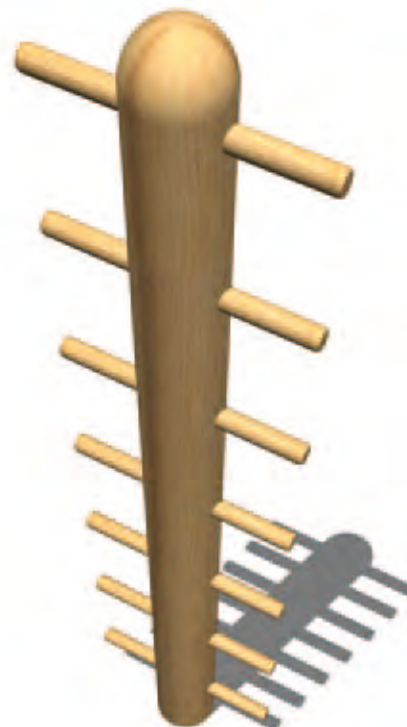

Attrezzi per l'arrampicata utilizzabili singolarmente o in combinazioni di più elementi.

Climbing fixtures can be used independently or in combination with each other.



Funivia 30 mt senza Rampe

ART. 011224

↕ 300 x 3000 h 290 cm

▭ 700 x 3800 cm

👤 5 -14

-68,16
Kg
CO₂



Funivia senza rampe, adatta per terreni in pendenza (dislivello consigliato circa 100 cm).

Lunghezza standard 30 metri, adattabile al luogo di posa.

Cableway without access ramp, ideal for slope lands (suggested difference in altitude about 100 cm)

Standard length 30 meters, can be adapted to the place of installation.





-113,17
Kg
CO₂

Funivia con 1 rampa

ART. 011228

↕ 300 x 3000 h 380 cm

▭ 700 x 3800 cm

🧑 5 -14

Funivia adatta a terreni livellati, con una torretta con rampa di partenza. Lunghezza standard 30 metri, adattabile al luogo di posa.

Cableway ideal for plain lands, with a tower and a departure ramp. Standard length 30 meters, can be adapted to the place of installation.

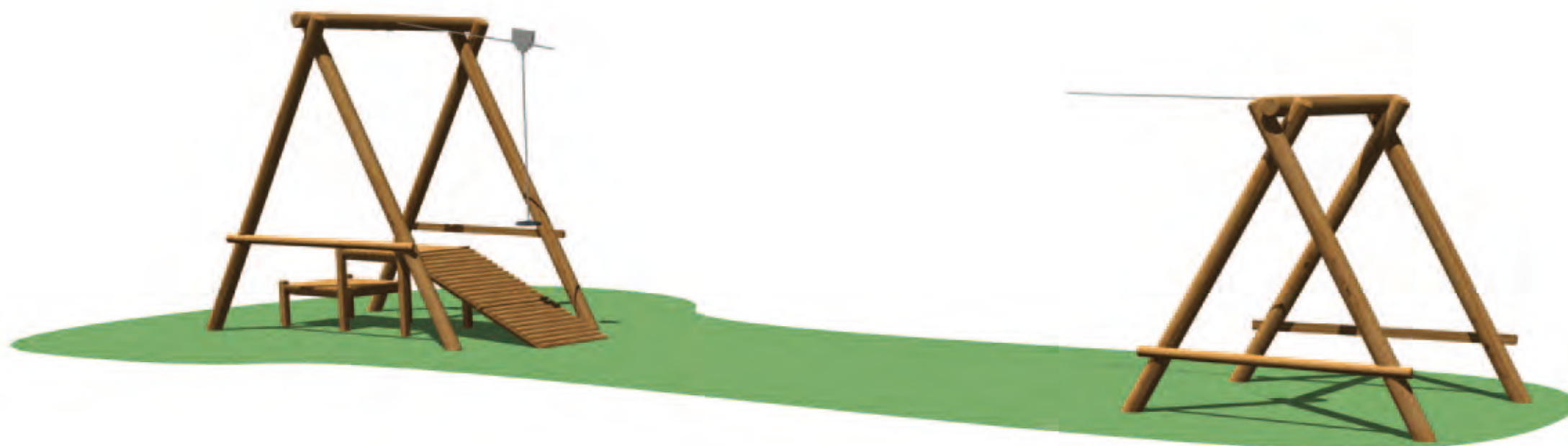



-22,33
Kg
CO₂

Dolomiti Climb

ART. 011225

↕ Ø 290 h 250 cm

▭ 517 x 546 cm

🧑 4 in sù

Struttura d'arrampicata con vari livelli di difficoltà. Gli appigli colorati raffigurano simpatici animaletti e le pareti servono anche come quinte per i giochi.

Multipurpose climbing system with different difficulty levels. The coloured pegs are in the shape of funny animals and the walls provide the scenario for children's games.

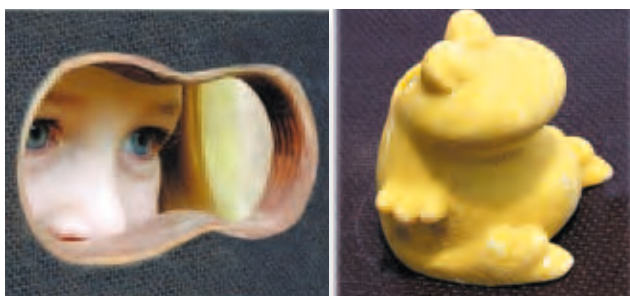

-13,92
Kg
CO₂

Arrampicata Climber

ART. 011074

↕ 14 x 158 h 230 cm

▭ 314 x 458 cm

🧑 4 in sù



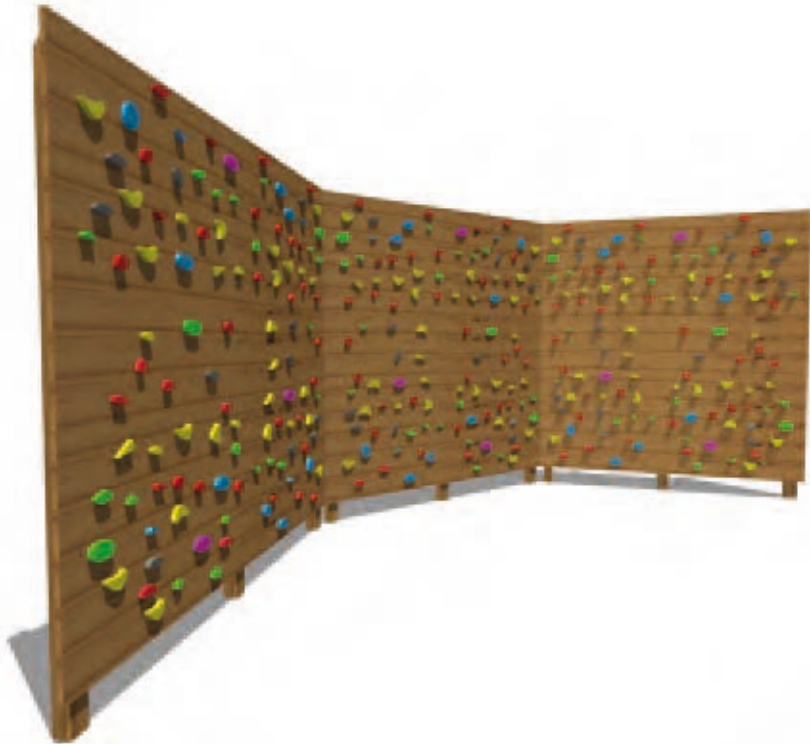

Grande parete di arrampicata che si sviluppa su percorsi orizzontali. Gli appigli di vario colore, determinano la difficoltà dei percorsi. **NOTA:** questa struttura non è un gioco per parco ma una struttura artificiale di arrampicata (norma EN 12572).

Big climbing wall on routes that spread horizontally. The handles are of various colours which determine the difficulty of the routes. **NOTE:** This facility is not a playground game but an artificial climbing structure (according to EN 12572).

-54,30
Kg
CO₂

Boulder Horizontal Wall

ART. 011218

650 x 200 h 280 cm

1000 x 500 cm

6 in sù





-84,20
Kg
CO₂

Vita Park Station

ART. 011317

945 x 1064 x h 238 cm

1257 x 1413 cm

4 in sù





-31,33
Kg
CO₂

Combigym

ART. 011160

152 x 300 h 237 cm

568 x 716 cm

3-14



Palestre multifunzione per l'arrampicata e l'attività ginnica, con diversi livelli di difficoltà.

Multi-function gyms that promote climbing and other physical activity, with different difficulty levels.



-45,91
Kg
CO₂

Combigym Plus

ART. 011162

152 x 500 h 237 cm

568 x 916 cm

3 in sù





Net Mountain 250

ART. 012084

↕ Ø 380 h 250 cm

▭ Ø 680 cm

👤 5-11

Arrampicate su rete a forma piramidale. Funi sintetiche colorate con anima in acciaio e pilastro centrale in acciaio zincato. Posa ideale su sottofondo in ghiaio o corteccia, e fissaggio a terra con blocchi di ancoraggio interrati.

Pyramidal net climbers. Synthetic coloured ropes with steel core and galvanized steel central pillar. Ideal installation on gravel or bark and attachment to buried anchor blocks.



Net Mountain 300

ART. 012085

↕ Ø 450 h 300 cm

▭ Ø 750 cm

👤 5-11





Net Mountain Maxi

ART. 012086

↕ Ø 710, h 450 cm

▭ Ø 1100 cm

👤 6 - 14



Net Mountain Galaxy

ART. 012087

↕ Ø 1040 h 650 cm

▭ Ø 1440 cm

👤 6 - 14

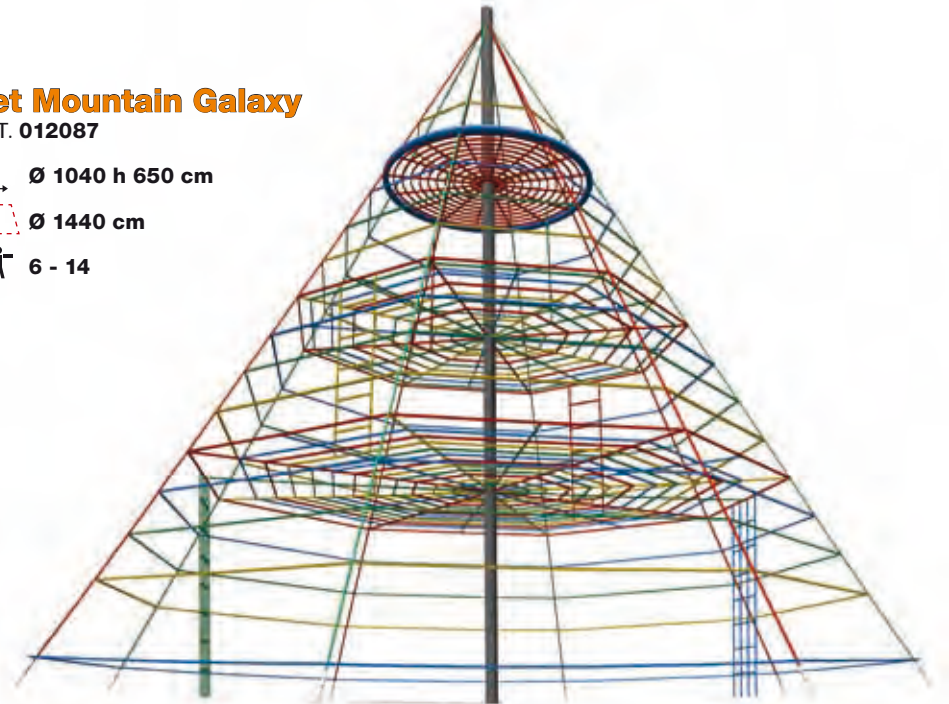





Space Ship - K
 ART. 012184
 ↕ Ø 160 x h 150 cm
 ▭ Ø 500 cm
 👤 3 -11

Space Ship - A
 ART. 012185
 ↕ Ø 200 x h 300 cm
 ▭ Ø 500 cm
 👤 3 -11



Giochi dinamici per socializzare, ideali per le diverse età. Diametro da 160 a 200 cm. Altezza max 300 cm.

Playground equipment that promotes socialization, ideal for different ages. Diameter from 160 cm to 200 cm. Max height 300 cm.



Space Ship - C
 ART. 012187
 ↕ Ø 160 h 300 cm
 ▭ Ø 600 cm
 👤 3 -11

Space Ship - D
 ART. 012188
 ↕ Ø 200 h 300 cm
 ▭ Ø 700 cm
 👤 3 -11





Capanna a palafitta su due livelli con ingressi frontale e laterale.

Stilt hut with two levels and with front and side entrance.

-61,05
kg
CO₂

Play tent Plus

ART. 011018

↕ 314 x 224 h 205 cm

▭ 614 x 524 cm

👤 3 -14





-37,53
Kg
CO₂

Baby Tent

ART. 011014

↕ 200 x 200 h 163 cm

▭ 500 x 500 cm

👤 2 -11



Classica capanna “alla canadese” per il gioco e il rifugio dei bambini. Spaziosa e robusta, con pavimento sollevato dal terreno.

Classic “Canadian” shed for children. Comfortable and sturdy, with raised floor.

-46,01
Kg
CO₂

Rifugio Natura

ART. 011019

↕ 192 x 212 h 204 cm

▭ 450 x 500 cm

👤 2 -11



Casetta con verandina ed arredo interno, di facile inserimento in aree verdi pubbliche e private.

Hut with a small veranda and furniture that is easy to integrate into any public or private outdoor area.



Vera e propria casetta con pavimento e veranda, utile anche come deposito di attrezzi scolastici per l'attività all'aria aperta.

Pareti in perline spessore 28 mm incastrate agli angoli. Optionals: serramenti, grondaie, arredo interno, portafiori e lavagna. A richiesta può essere fornito il CATALOGO BAITE.

Real house with floor and veranda, it can be employed also as a deposit for outdoor educational equipment.

Walls with matchboard structure thickness 28 mm and embedded corners. Optional: doors and windows, gutters, furniture, jardinière and blokboard.

The ALPINE CHALET CATALOGUE is available on demand.



-47,92
Kg
CO₂

Play house

ART. 011010

200 x 350 h 200 cm

500 x 650 cm

2 - 11



-13,17
Kg
CO₂

Joy house

ART. 012050

148 x 157 h 152 cm

448 x 557 cm

2 - 8

Robusta casetta in polietilene riciclabile al 100%, con pavimento in legno e arredo interno. Non richiede manutenzione.

Sturdy hut made of 100% recyclable polyethylene, with wooden floor and furniture. Maintenance free.





I dondoli sono gli attrezzi base per parchi gioco pubblici e privati. Sono dotati di cuscinetti a sfere autolubrificanti e di dispositivi per l'assorbimento degli urti a terra.

Seesaws are the basic equipment in public and private playgrounds. They are provided with self-lubricating ball bearings and shock-absorbing safety flooring.

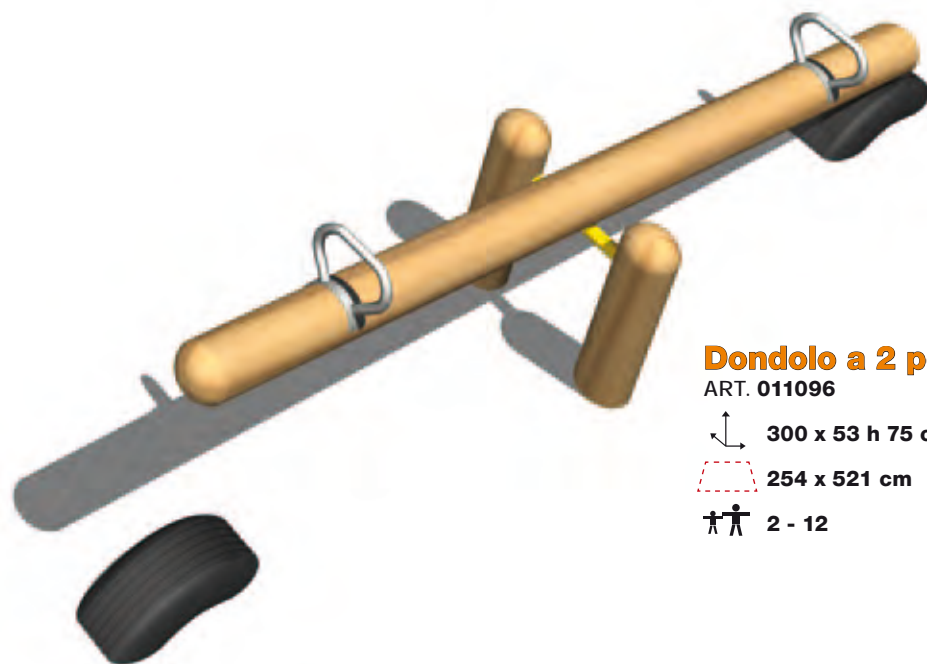

Dondolo a 2 posti fisso

ART. 011096

↕ 300 x 53 h 75 cm

▭ 254 x 521 cm

👤 2 - 12

-6,95
Kg
CO₂

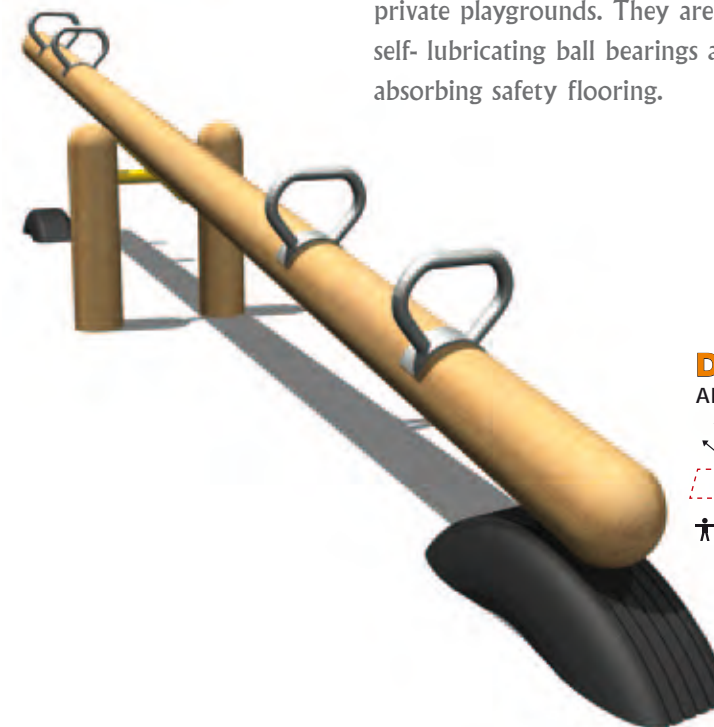

Dondolo a 4 posti fisso

ART. 011100

↕ 400 x 53 h 75 cm

▭ 254 x 621 cm

👤 2 - 12

-8,25
Kg
CO₂



Dondolo originale con una pedana centrale, che
aumenta la possibilità di gioco.
Mollone con dispositivo antischiacciamento.

Original seesaw with a central step board that
increases the number of play opportunities.
Springs embedded with anti-trapping device.

Twin Parrot

ART. 011432

↓ 250 x 25 h 85 cm

▭ 450 x 425 cm

👤 2-8



-68,00
Kg
CO₂

Coccodrillo Spring

ART. 011217

↓ 300 X 36 h 69 cm

▭ 600 x 336 cm

👤 2-8

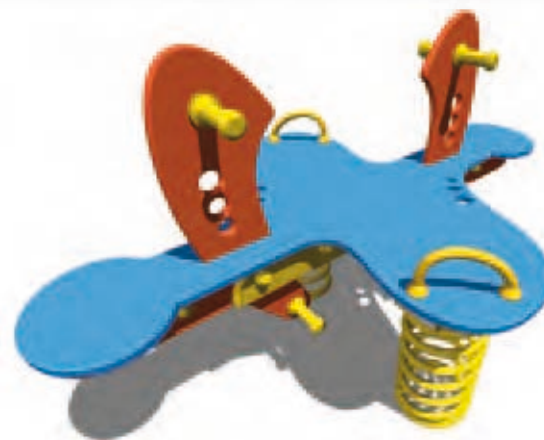

Twin Think

ART. 011433

↓ 130 x 100 h 85 cm

▭ 330 x 300 cm

👤 2-8





Cavalluccio Natura

ART. 011115

83 x 40 h 94 cm

240 x 282 cm

2 - 6

-3,00
Kg
CO₂

Giochi a molla “tutto legno”, per l’inserimento in aree che richiedono colori naturali, a basso impatto cromatico.

Spring rockers “solid wood” can be integrated into areas that require natural colours, with low chromatic impact.



Bambi Natura

ART. 011116

83 x 40 h 94 cm

240 x 282 cm

2 - 6

-3,00
Kg
CO₂

Serie Think Spring

Tutti/All Models

23 x 70 h 87 cm

Ø 300 cm

2 - 9



Think Spring 1

ART. 011401



Think Spring 2

ART. 011403



Think Spring 3
ART. 011407



Think Spring 4
ART. 011405



Think Spring 5
ART. 011409



Innovativi giochi a molla di forme astratte per incuriosire e stimolare la fantasia dei bambini. In polietilene riciclabile spessore 20 mm, non richiedono manutenzione.

Innovative spring rockers with abstract shapes to stimulate child curiosity and imagination. Made of recyclable polyethylene 20 mm thick, maintenance free.



Giochi a molla in polietilene spessore 20 mm.
Spring rockers in polyethylene 20 mm thick.

Parrot

ART. 011430

23 x 92 h 89 cm

225 x 250 cm

2 - 8

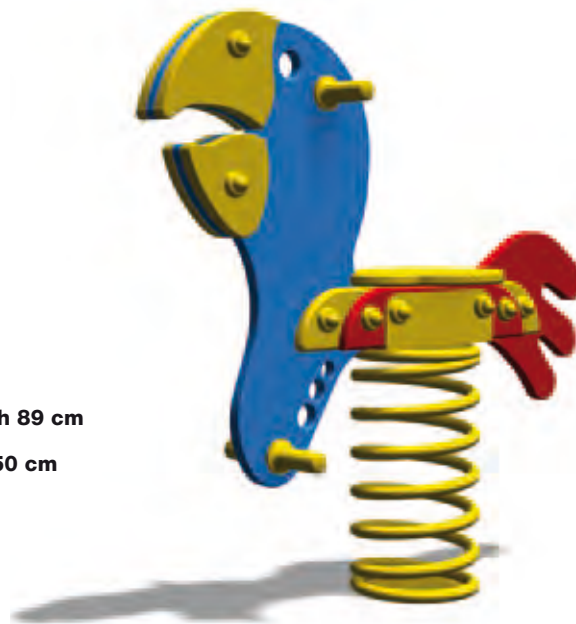

Fiuto

ART. 012603

23 x 94 h 89 cm

225 x 250 cm

2 - 8



Aladar

ART. 012604

23 x 88 h 88 cm

225 x 250 cm

2 - 8

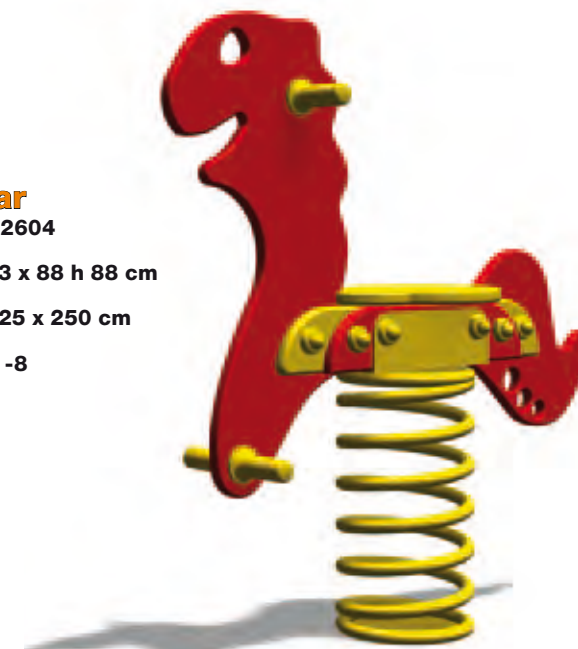

Spirit

ART. 012601

↓ 23 x 88 h 89 cm

225 x 250 cm

2-8



Rocco

ART. 011435

↓ 23 x 82 h 90 cm

225 x 250 cm

2-8



Vespino

ART. 012602

↓ 23 x 80 h 85 cm

225 x 250 cm

2-8

Emil

ART. 012614

↓ 23 x 90 h 90 cm

225 x 250 cm

2-8





Giochi a molla in polietilene spessore 20 mm.
La versione con schienale è adatta anche ai
meno abili.

Spring rockers in polyethylene 20 mm thick.
The version with back rest is also suitable for
disabled people.

Serie Multi Spring

Tutti/All Models

 84 x 73 h 92 cm

 300 x 400 cm

 2 - 8



Multi Spring 1
ART. 011420



Multi Spring 2
ART. 011422

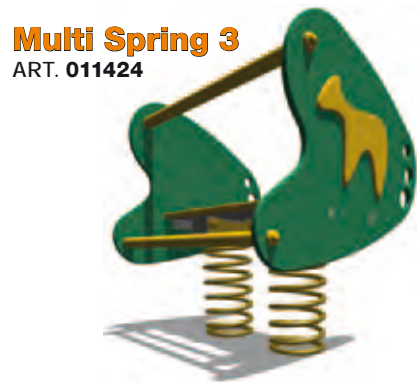

Multi Spring 3
ART. 011424



Multi Spring 4
ART. 011426



Multi Spring 5
ART. 011429



Gioco a molla a doppia parete, sicuri anche per i più piccoli e i meno abili, da 1 a 3 posti.

Spring rockers with double sidewalls, safer for younger children and disabled people, from 1 to 3 seats.



Fantasy Spring 1

ART. 011410



Serie Fantasy Spring

Tutti/All Models

49 x 73 h 92 cm

Ø 300 cm

2-8



Fantasy Spring 3

ART. 011414



Fantasy Spring 2

ART. 011412



Fantasy Spring 4

ART. 011416



Fantasy Spring 5

ART. 011419



Giochi a molla a doppia parete, sicuri anche per i più piccoli. Design astratto e innovativo, studiato per stimolare la fantasia dei bambini.

Spring rockers with double sidewalls safer for younger children. Abstract and innovative design that has been implemented to stimulate child imagination.



Fragola Spring

ART. 017114

46 x 72 h 83 cm

250 x 250 cm

1 - 6

Tutti/All models

44 x 77 h 91 cm

250 x 250 cm

2 - 6



Cinquecento

ART. 012622



Moby

ART. 012621



Elefy

ART. 012623

Giochi a molla a doppia parete, per i più piccoli e meno abili, in polietilene riciclabile spessore 20 mm.

Spring rockers with double sidewalls, safer for younger children and disabled people, made of recyclable polyethylene 20 mm thick.

Tutti/All models

86 x 72 h 83 cm

290 x 250 cm

1 - 6

Fragola Multi-Spring

ART. 017124

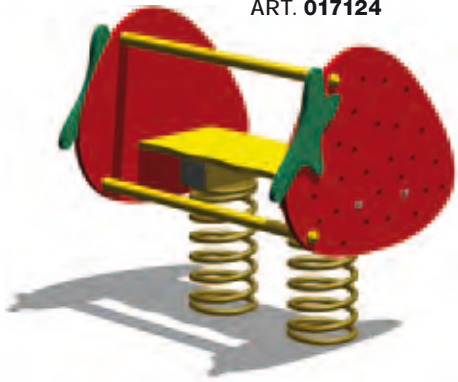

Elefy - 3 posti

ART. 012633



Moby - 3 posti

ART. 012631



Giochi a molla multiposto, in polietilene riciclabile spessore 20 mm, favoriscono l'aggregazione.



Cinquecento - 3 Posti

ART. 012632

84 x 81 h 93 cm

290 x 250 cm

2 - 6

Multi-child spring rockers, made of recyclable polyethylene 20 mm thick, to promote socialization.



Banana Spring

ART. 017113

↕ 125 x 23 h 82 cm

▭ 225 x 325 cm

👤 2 - 8

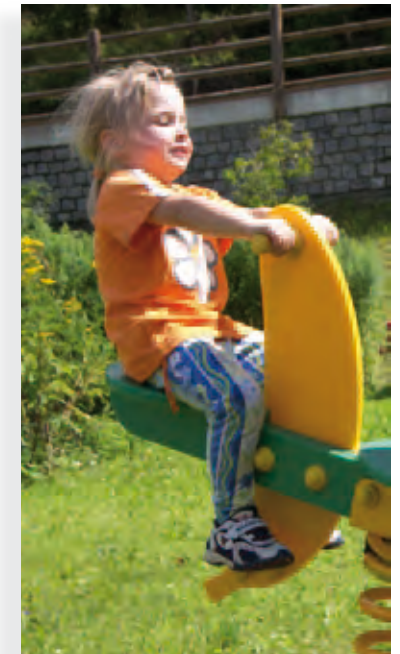

Giochi a molla multiposto per 2-3 bambini,
realizzati in polietilene riciclabile sp. 20 mm.

Multi-child spring rockers for 2-3 children,
made of recyclable polyethylene 20 mm thick.

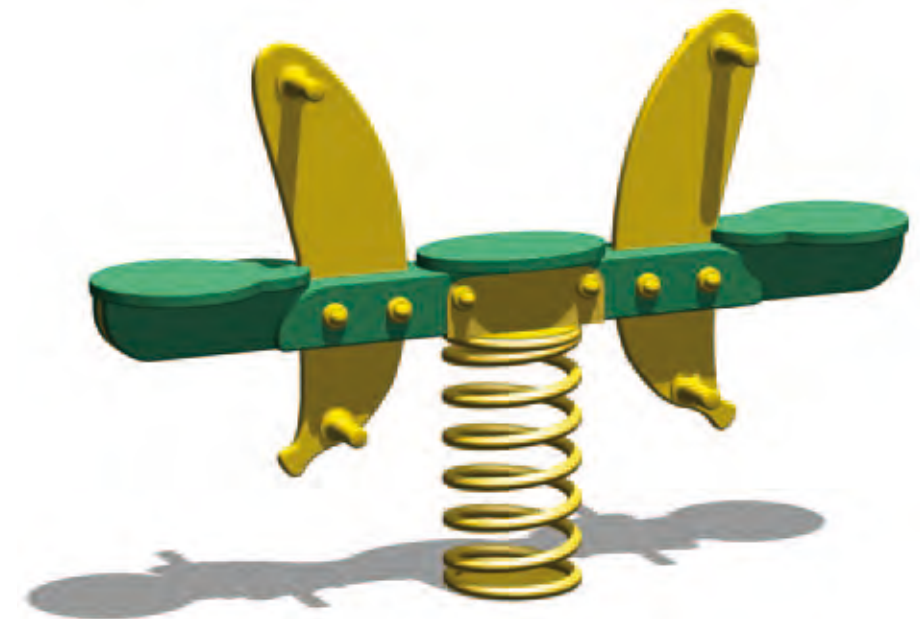

Rocco Doppio

ART. 011440

↓ 125 x 23 h 92 cm

▭ 225 x 325 cm

👤 2-8





Giostra Fiorella

ART. 012410

↑ ∅ 140 x h 94

∅ 540 cm

3 - 8



Innovativa giostra rotante realizzata in acciaio, e polietilene, con pianale in alluminio anti-sdruc-ciolo. Non richiede manutenzione.

Innovative roundabout made of steel and polyethylene with anti-skid aluminium platform. Maintenance free.

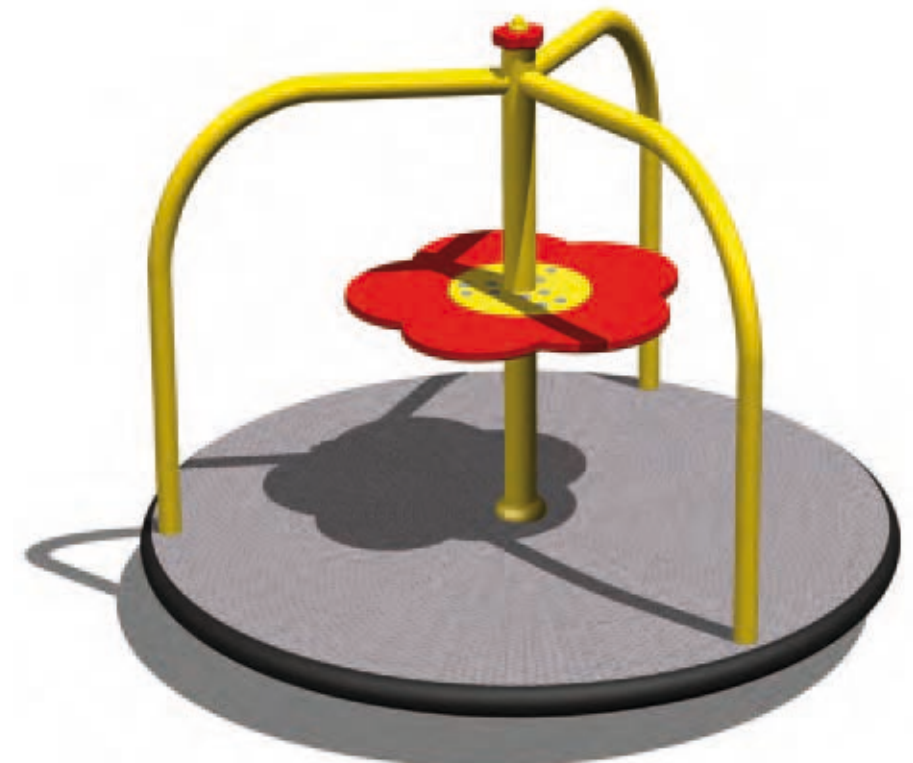

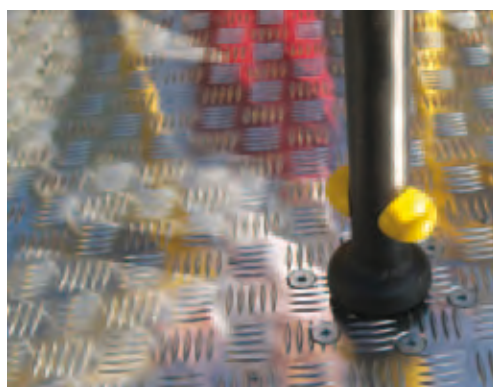

Giostra arricchita con un elemento didattico originale: la bussola inserita al centro del manubrio permette ai bambini di familiarizzare con il concetto del "Nord". Molto resistente, non richiede manutenzione.

This roundabout is enhanced with an original didactic element: a compass embedded at the centre of the handlebar helps the children understand the concept of "North". Highly resistant, maintenance free.

Giostra Compass

ART. 011208

↑ ↓ Ø 140 x h 74



⬡ Ø 540 cm

👤 3 - 8



-3,48
Kg
CO₂

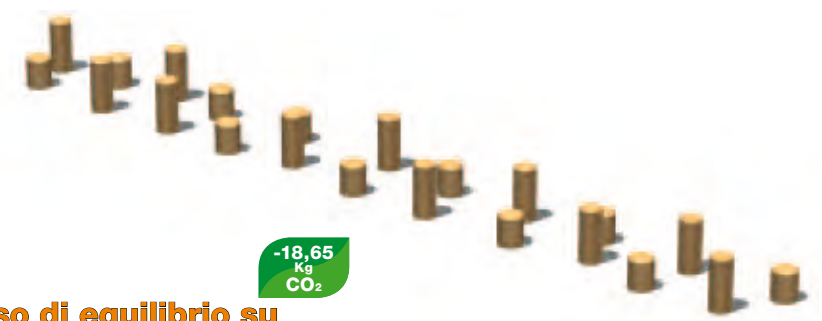

Percorso Jumpy

ART. 011123
 455 x 172 x h 43
 655 x 352 cm
 3 - 11



-18,65
Kg
CO₂

Percorso di equilibrio su tronchi

ART. 011070
 75 x 575 h 35
 375 x 875 cm
 3 in sù

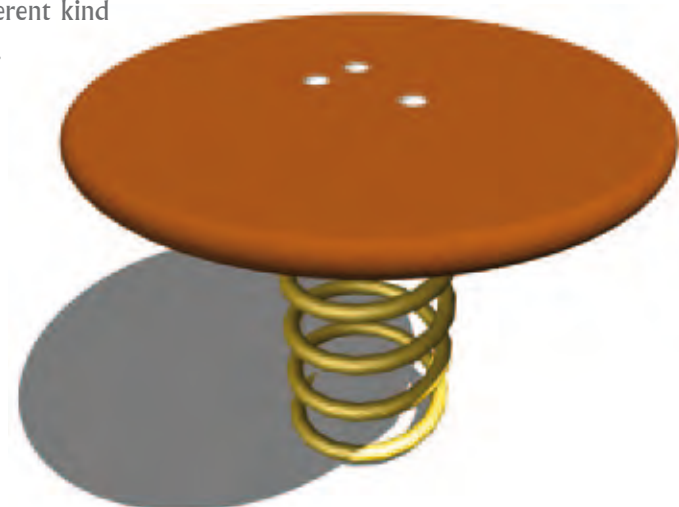

Percorsi di abilità su diversi tipi di ostacolo, singoli o montati in successione.

Skill developing trails with different kind of obstacles: single or multiple.



-0,58
Kg
CO₂

Jumpy

ART. 011107
 Ø 54 x h 43
 Ø 300 cm
 3 - 11





-4,46
Kg
CO₂

Asse di equilibrio

ART. 011060

↓ 14 x 300 h 35

▭ 314 x 600 cm

👤👤 3 in sù



-12,04
Kg
CO₂

Ponticello Mobile Fruts

ART. 016021

↓ 40 x 205 h 36 cm

▭ 340 x 505 cm

👤👤 3 - 8

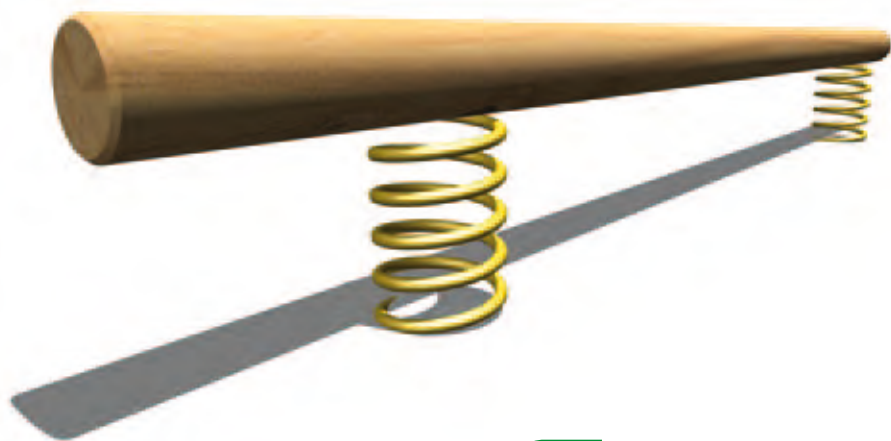

-3,90
Kg
CO₂

Asse su molle

ART. 011212

↓ 20 x 300 h 40 cm

▭ 214 x 500 cm

👤👤 3 in sù

-17,95
Kg
CO₂

Percorso di equilibrio su asse

ART. 011065

↓ lunghezza 900 cm

▭ 600 x 900 cm

👤👤 3 in sù





-70,90
Kg
CO₂

Arena dei bambini

ART. 011220

500 x 272 h 155

840 x 580 cm

3 - 14

Grande Arena per il teatro e l'attività didattica all'aria aperta, può ospitare fino a 40 bambini. Utile optional la grande pedana in legno.

Large arena that can be used as a theatre or for outdoor educational activity, hosts up to 40 children. Useful optional is a large wood stage.

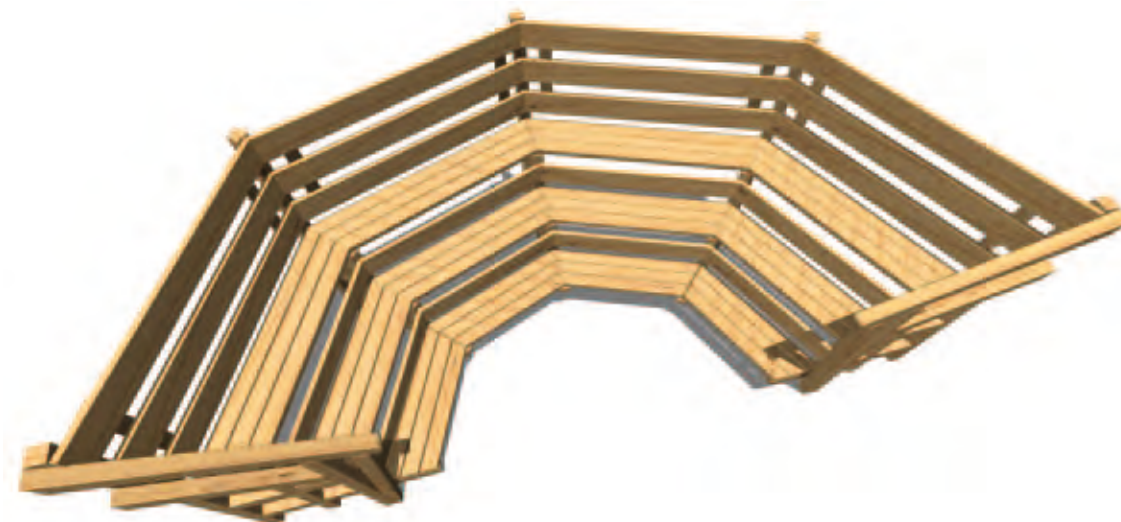

Le sabbie, importanti in tutti i parchi gioco, sono offerte in tre forme e dimensioni diverse:

Sabbiera m. 2x2 (Art. 011031)

Sabbiera m. 3x3 (Art. 011030)

Sono disponibili teloni in PVC microforato per proteggere la sabbia da pioggia e animali. la sabbia viene fornita a parte (Art. 200753).

The sandpits, fundamental for every playground, are available in 3 shapes and sizes:

Sandpit mt. 2x2 (Art. 011031)

Sandpit mt. 3x3 (Art. 011030)

Micro perforated PVC coverings are available to protect sand from rain and animals. Sand is optionally provided (Art. 200753).

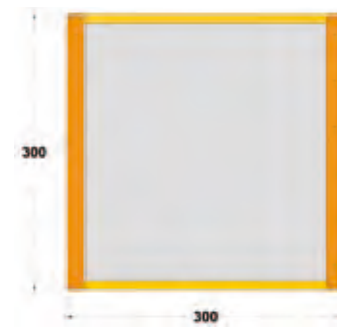
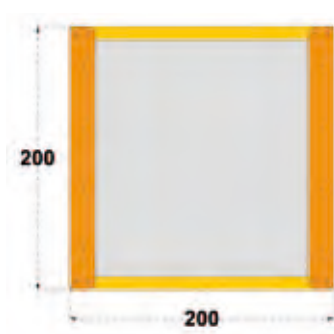



-67,48
Kg
CO₂

Sabbiera Coperchio Mobile 2,4x4

ART. 011025

240 x 423 h 48 (cop. chiuso)

540 x 1061 cm

2 in sù

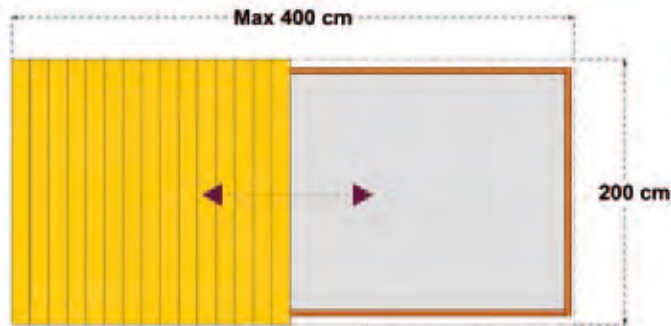
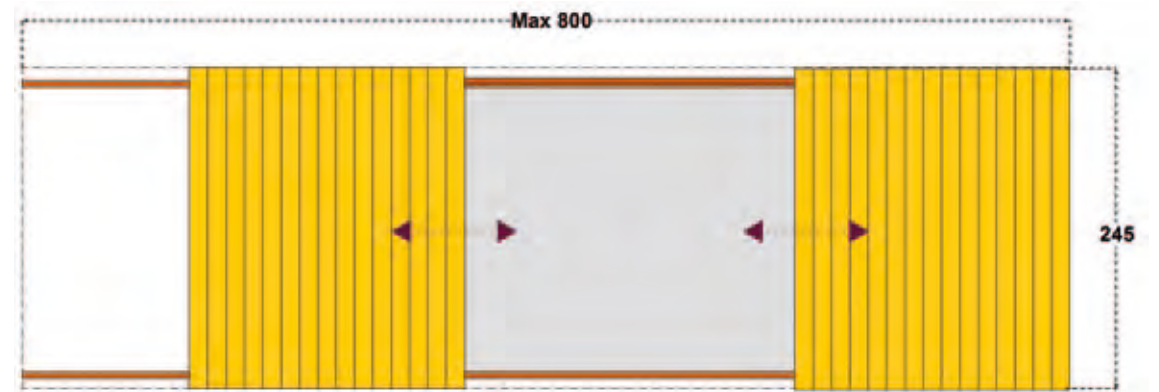

-32,71
Kg
CO₂

Sabbiera Coperchio Mobile 2x2

ART. 011026

200 x 200 h 48 (cop. chiuso)

500 x 680 cm

2 in sù

Sabbiera con robusti coperchi scorrevoli per proteggere la sabbia da pioggia e animali, con dispositivi di sicurezza.

Sandpit with solid sliding cover to protect sand from from rain and animals, with safety devices.





-3,65
Kg
CO₂

Tavolo di Manipolazione

ART. 011043

180 x 75 h 40 cm

375 x 480 cm

2 - 8



-16,18
Kg
CO₂

Multigioco per Acqua e Sabbia

ART. 011042

236 x 237 h max 70 cm

537 x 536 cm

2 - 11

Piani di lavoro su diversi livelli per attività didattiche e giochi all'aria aperta. La fontana in legno (Art. 011199) viene fornita a parte.

Working tables on different levels for outdoor educational activities.

The wood fountain (Art. 011199) is optionally available.



ORTO DIDATTICO - ORTICOLTURA giocare per crescere



PERSONALIZZA IL TUO ORTO DIDATTICO !

ARTICOLI PER ORTI DIDATTICI

 <p>Art. 071604-S VASCA PER ORTI DIDATTICI 1 Misure: 96x129 h 14 cm</p>	 <p>Art. 011238 RECINTO BASSO GARDEN BOY Misure: 14 x 151 h 63,5 cm</p>	 <p>Art. 011247 GARDEN BOY 1 Misure: Ø 60 h 120 cm</p>	 <p>Art. 011211-L-C CHIOCCIOLONA COLOR Misure: 192 x 36 h 59 cm</p>	 <p>Art. 011231-C BRUCONE COLOR Misure: 300 x 30 h 50 cm</p>
 <p>Art. 071607-S VASCA PER ORTI DIDATTICI 2 Misure: 96x188 h 28 cm</p>	 <p>Art. 011239 PANCA PER GARDEN BOY Misure: 32 x 129 h 23 cm</p>	 <p>Art. 011244 GARDEN BOY 2 Misure: 64 x 106 h 107 cm</p>	 <p>Art. 011241 RANA Misure: 35x60 h 59 cm</p>	 <p>Art. 154110 BACHECA TIPO 10 Misure: 90 x 20 h 250 cm</p>
 <p>Art. 011248 VASCA PER ORTI DIDATTICI BABY Misure: 165x80 cm h 65 cm</p>	 <p>Art. 011243 PALO RECINTO GARDEN BOY Misure: 30 x 63,5 h 110 cm</p>	 <p>Art. 011245 GARDEN BOY 3 Misure: Ø 60 h 82 cm</p>	 <p>Art. 011241-C RANA COLOR Misure: 35x60 h 59 cm</p>	 <p>Art. 011019 RIFUGIO NATURA Misure: 192 x 212 h 204 cm</p>
 <p>Art. 011240 COMPOSTER GARDEN BOY Misure: 67 x 122,5 h 59 cm</p>	 <p>Art. 011236 FIORIERA GARDEN BOY Misure: Ø 67 h 35 cm</p>	 <p>Art. 011246 GARDEN BOY FLOWER Misure: Ø 60 h 37 cm</p>	 <p>Art. 011233 COCCINELLA Misure: 55x130 H 59 cm</p>	 <p>Art. 011014 BABY TENT Misure: 200 x 200 h 163 cm</p>
 <p>Art. 011237 RECINTO ALTO GARDEN BOY Misure: 16 x 252 h 83,5 cm</p>	 <p>Art. 011242 FONTANA GARDEN BOY Misure: 48 x 86 h 137 cm</p>	 <p>Art. 011211-L CHIOCCIOLONA Misure: 192 x 36 h 59 cm</p>	 <p>Art. 011231 BRUCONE Misure: 300 x 30 h 50 cm</p>	 <p>Art. 017112 GRUPPO ARANCIA Misure: 140 x 125 h 30/54 cm</p>



Tavolo di manipolazione dotato di due vasche estraibili, con coperchi, per sabbia e acqua.
Ripiano e coperchi sono in polietilene riciclabile.

The working table is enhanced with two removable basins, with lids, for sand and water.
Recyclable polyethylene shelf and lid.

-2,72
Kg
CO₂

Vasca per acqua e sabbia

ART. 011044

↙ 92 x 123 h 50 cm

▭ 200 x 200 cm

🧑 2 - 11



-5,67
Kg
CO₂

Sabbiera Fruts

ART. 016017

↙ 77 x 181 h19 cm

▭ 481 x 377 cm

🧑 2 - 8





-129,15
Kg
CO₂

Trattore

ART. 011202

130 x 360 h 112 cm

430 x 650 cm

2 - 11

Gioco di fantasia completamente realizzato con tronchi di legno di grande diametro, lavorati a mano. Il legno massiccio è un materiale vivo, soggetto a possibili fessurazioni non pericolose.

Fantasy game entirely made of large diameter logs, hand carved.

Solid wood is a living material, subject to possible non-dangerous splitting.

-95,27
Kg
CO₂

Trattore solo motrice

ART. 011203

158 x 130 h 112 cm

450 x 430 cm

2 - 11



Gioco figurativo realizzato completamente in legno lamellare, offre il libero sfogo della capacità immaginativa e creativa dei bambini più piccoli, inoltre arreda in modo originale qualsiasi spazio pubblico o privato.

Figurative play structure, made entirely of laminated wood, offers free playing to enhance imagination and creativity of younger children. It is also an original furnishing element in any public or private space.

-276,00
Kg
CO₂

Chiocciolona

ART. 011211-L

192 x 36 h 59 cm

492 x 336 cm

da 2 anni



-45,26
Kg
CO₂

Porcellino

ART. 011213

60 x 117 h 74 cm

360 x 417 cm

2 - 8

Giochi di fantasia completamente realizzati con tronchi di legno di grande diametro, lavorati a mano. Il legno massiccio è un materiale vivo, soggetto a possibili fessurazioni non pericolose.

Fantasy game entirely made of large diameter logs, hand carved. Solid wood is a living material, subject to possible non-dangerous splitting.

-8,41
Kg
CO₂

Topolino

ART. 011215

35 x 88 h 39 cm

235 x 260 cm

2 - 8



-45,27
Kg
CO₂

Tunnel Classic

ART. 011190

↑ 113 x 245 h 95 cm

▭ 410 x 550 cm

👤 2 - 11



Il treno occupa da sempre un posto importante nella fantasia dei bambini.

Il gioco, completamente in legno, è composto da locomotiva, carrozza passeggeri e vagoni merci.



-71,23
Kg
CO₂

Treno Natura

ART. 011201

↑ 90 x 570 h 167 cm

▭ 390 x 870 cm

👤 3 - 8

Trains have always played an important role for child fantasy. This fixture, entirely made of wood, is made of a locomotive, a passenger car and a freight car.



Tunnel con struttura in robusti pali di legno e telaio interno in acciaio. Il lato esterno può essere utilizzato anche come arrampicata.

Tunnel with a solid structure made of wood poles and an internal steel frame. The external side can be also used as a climber.





-3,71
Kg
CO₂

Canestro Semplice

ART. 011166

↕ 45 x 67 h 220 cm

⊞ 350 cm

🧑 3 - 14

Canestro singolo con robusto montante in legno per il gioco dei piccoli, ideale per le scuole dell'infanzia e i parchi attrezzati.

Single basketball hoop with sturdy wood post for small children, ideal for nursery schools and parks.



Impianto Basket Monotubo

ART. 011169

↕ coppia di canestri completi

🧑 da 5 anni

Impianto Basket Olimpionico

ART. 011164

↕ coppia di canestri completi

🧑 da 5 anni



-4,24
Kg
CO₂

Scivolo da Pendio 620 cm

ART. 011139

↕ 64 x 620 cm

⊞ 360 x 970 cm

🧑 3 - 14

Scivoli per colline e pendii naturali o artificiali. I percorsi sono componibili in varie misure.

Slide for hills and natural or artificial slopes. The slide path is modular and available in various sizes.

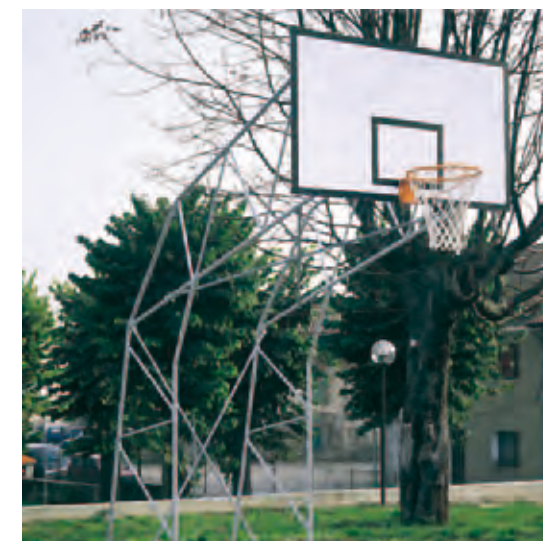

Tavolo da Ping Pong da esterno

ART. 011068

572 x 453 cm

3 in sù



Indistruttibili: montanti in legno diametro 160 mm e reti sintetiche con anima in metallo che resiste a tutte le sollecitazioni, anche di tipo vandalico. Misure regolamentari, adatte ad ogni età, e nessuna manutenzione.

Indestructible: wood posts diameter 160 mm and synthetic nets with metallic core, stress proof, even abuse resistant. Regular size, ideal for every age, maintenance free.

-20,39
Kg
CO₂

Porta Calcio per aree Incustodite

ART. 011168

300 x 250 h 240 cm

750 x 550 cm

3 in sù



Tappeto elastico Piccolo

ART. 012091

175x150 cm

475x450 cm

3 - 11



Tappeto elastico Grande

ART. 012092

300x200 cm

600x500 cm

3 - 11

Porte da calcetto Regolamentari

ART. 011176

coppia 300 x 200 cm

3 in sù

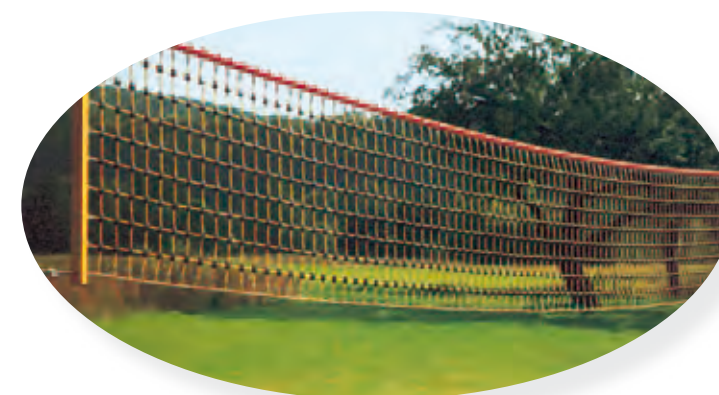

Rete Volley per aree Incustodite

ART. 011167

20 x 950 h 250 cm

5 in sù

-13,59
Kg
CO₂



Percorso Fitness: Vita Parcours



Percorso Vita con indicazioni in Italiano, Inglese e Tedesco. Ogni stazione è completa di un attrezzo specifico con certificato di sicurezza e di una tabella illustrativa con la descrizione degli esercizi da svolgere in funzione del livello di allenamento degli utenti.

Disponibile in tre tipologie:

Trim trail with signposts in Italian, English, and German. Every station has a specific training equipment with safety certificate and an illustrated table that describes the different training exercises for every user level.

Available in tree types:

-37,27
Kg
CO₂ **Vita Parcours 8 Stazioni (ART. 011148)**
dalla stazione di inizio percorso alla stazione n°7

-79,96
Kg
CO₂ **Vita Parcours 13 Stazioni (ART. 011165)**
dalla stazione di inizio percorso alla stazione n°12

-112,2
Kg
CO₂ **Vita Parcours 17 stazioni (ART. 011178)**
dalla stazione di inizio percorso alla stazione n°16

Tutte le stazioni sono certificate UNI EN 1176:2008 e pertanto sono adatte anche per il gioco dei bambini.

All stations are certified UNI EN 1176:2008 and are therefore suitable for playing children.



Percorso Fitness VITA PARK KUR



ART. 011300



ART. 011301



ART. 011302



ART. 011303



ART. 011304



ART. 011305



ART. 011306



ART. 011307





ART. 011308



ART. 011309



ART. 011310



ART. 011311



ART. 011312



ART. 011313



ART. 011314

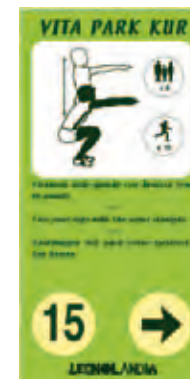

ART. 011315



ART. 011316



EASY ADVENTURE

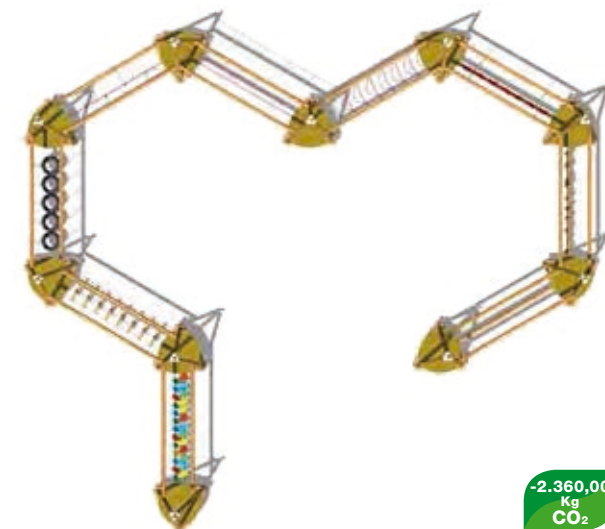

-2.360,00
Kg
CO₂

Easy Adventure 10

ART. 202050

Percorso lungo - 10 stazioni

Long route - 10 stations



-1.180,00
Kg
CO₂

Easy Adventure 5

ART. 202051

Percorso corto - 5 stazioni

Short route - 5 stations

EASY ADVENTURE:

Percorsi avventura per il gioco, lo sviluppo motorio e dell'equilibrio composti da passaggi di varia difficoltà. Si contraddistinguono per la limitata altezza di caduta (< di 60 cm), per questo motivo possono essere utilizzati anche su superfici solide come piazze, spazi cementati o asfaltati (anche indoor) senza l'ausilio di pavimentazioni anti-trauma. Le strutture sono modulari, il cliente ha la possibilità di scegliere la composizione preferita tra 9 tipi di "ponti" di diversa difficoltà. Il modulo base, torre di partenza arrivo e stazionamento, è dotato di ampio ripiano rialzato posto a 58 cm da terra. La lunghezza fissa dei ponti è di 350 cm.

Adventure course for playing and the development of motor abilities and balance. The courses are characterized by limited fall height (less than 60 cm), therefore they can also be used on solid surfaces such as cemented or asphalted pavements without the necessity of shock absorbing devices. The structures are modular, the customer can choose the preferred composition out of 9 types of "bridges" of different difficulty. The base module = tower of arrival and departure and intermediate station, has a wide area placed at 58 cm from the ground. The length of the bridges is 3,5 meters.



L'utilizzo è suggerito per utenti da 8 anni in su, ma applicando i maniglioni (opzionali art. 202155) l'attività può diventare adatta anche per utenti più piccoli.

Its use is recommended for users from 6 years up, but with the option of a long handles (optionals art. 202155) the activity is suitable even for young children.



**EASY
ADVENTURE**

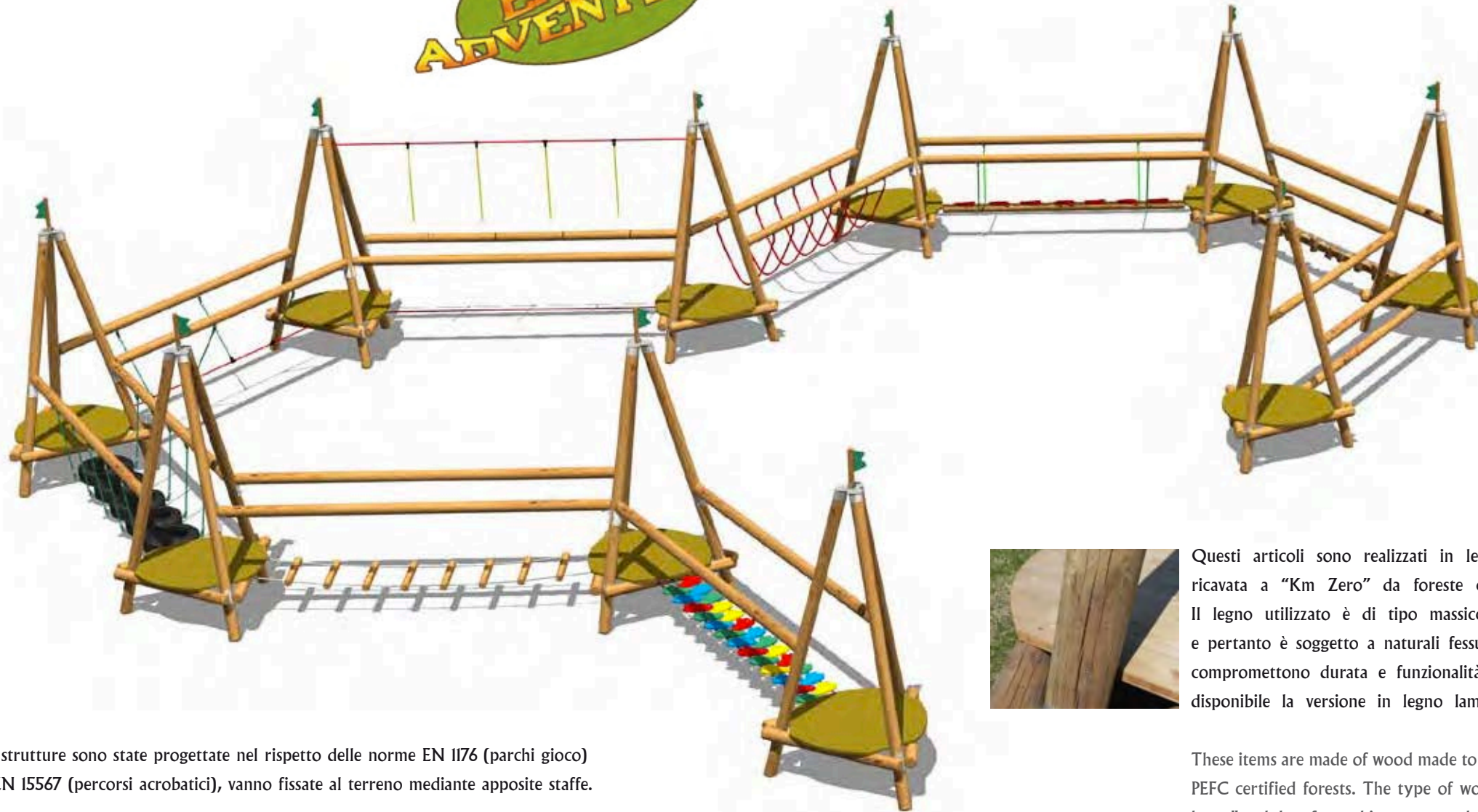

Questi articoli sono realizzati in legno di conifera ricavata a "Km Zero" da foreste certificate PEFC. Il legno utilizzato è di tipo massiccio "con cuore" e pertanto è soggetto a naturali fessurazioni che non compromettono durata e funzionalità. Su richiesta è disponibile la versione in legno lamellare cilindrico.

Le strutture sono state progettate nel rispetto delle norme EN 1176 (parchi gioco) e EN 15567 (percorsi acrobatici), vanno fissate al terreno mediante apposite staffe.

The structures were designed in compliance with EN 1176 and EN 15567 (acrobatic courses), and can be fixed to the ground with brackets.

These items are made of wood made to "Km Zero" from PEFC certified forests. The type of wood used is "with heart" and therefore subject to natural cracks that do not compromise durability and functionality. On demand is also available the cylindrical laminated wood version.



Base-Tower Easy Adventure

ART. 202100

-113,00
Kg
CO₂



Base torretta modulare
Base of modular tower

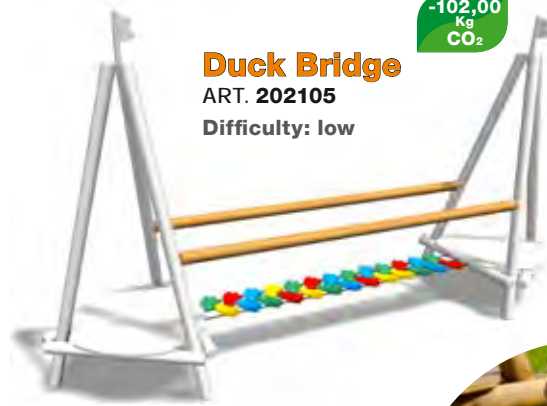

Duck Bridge

ART. 202105

Difficulty: low

-102,00
Kg
CO₂

Ponte su sagome colorate
Mobile coloured patterns



Logs Bridge

ART. 202110

Difficulty: medium-low

-140,00
Kg
CO₂



Ponte su pioli mobili
Mobile wood bridge



Tyre Bridge

ART. 202115

Difficulty: medium-low

-102,00
Kg
CO₂

Ponte pneumatici riciclati
Recycled tyres bridge



Cross Rope Bridge

ART. 202120

Difficulty: medium-low

-102,00
Kg
CO₂

Ponte tibetano
Tibetan bridge



Tight Rope Bridge

ART. 202125

Difficulty: medium-low

-102,00
Kg
CO₂

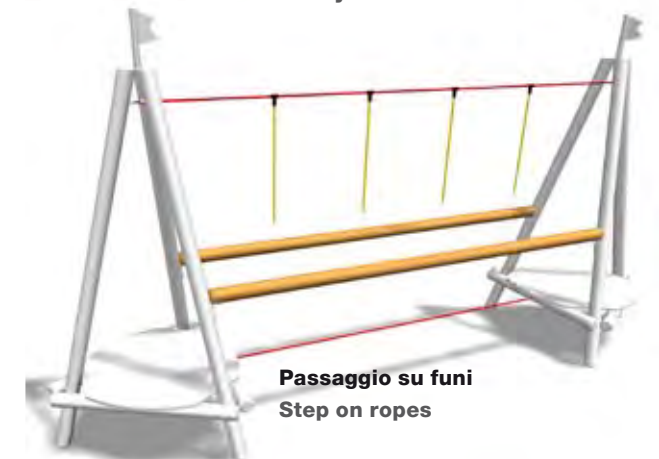

Passaggio su funi
Step on ropes



-102,00
Kg
CO₂

Swinging Ropes Bridge

ART. 202130

Difficulty: medium



Ponte su funi libere
Free ropes bridge



-132,00
Kg
CO₂

Big Foot Bridge

ART. 202135

Difficulty: high



Ponte su asse semi-rotante
Partially rotating beam bridge



-132,00
Kg
CO₂

Rotating Beam Bridge

ART. 202145

Difficulty: very high



Ponte su asse rotante
Rotating beam bridge



Baby Net Easy-Adventure

ART. 202150

Rete di sicurezza
Safety net



-140,00
Kg
CO₂

Chaotic Bridge

ART. 202140

Difficulty: high



Ponte su pioli rotanti
Bridge on rotating logs

C'è la possibilità di personalizzare le attività selezionando a proprio piacimento i tipi di passaggio.

You can customize the course with the components selected from the list.

Argentovivo



LEGNOLANDIA *Benessere*



ARGENTOVIVO

Argentovivo, Area benessere.

Negli ultimi decenni i cambiamenti nelle abitudini quotidiane delle persone hanno influito molto sulla loro condizione fisica causando, anche in età relativamente bassa (40 anni), varie problematiche fisiche su muscoli ed articolazioni. Lo scopo di questo impianto è quello di permettere una leggera attività fisica in forma controllata e in modo divertente.

Argentovivo, Wellness area.

Since some decades, the changes in the daily habits of the people have a great influence on their physical condition. This may cause even at a relatively low age (40 years), various physical problems of muscles and joints. The purpose of this system is to allow light physical activity in a controlled manner and in an entertaining way.



Disponibili in tre versioni:
Three versions available:



Pali zincati e verniciati (RAL 2003)
Galvanized and painted poles (RAL 2003)



Pali in legno lamellare
Gluelam wood poles



Pali in acciaio inox
Stainless steel poles

Altri materiali utilizzati: Laminato HPL, Polietilene ed alluminio.
Other materials used: HPL, polyethylene and aluminum.

Gli attrezzi rispettano le norme di sicurezza per i parchi gioco EN 1176, e pertanto sono adatte anche ai bambini che "accompagnano" le persone adulte al parco.

All equipment meets the safety standards for playgrounds EN 1176, and is therefore also suitable for children who "accompany" the adult people to the park.



ARGENTOVIVO, area benessere.

Negli ultimi decenni i cambiamenti nelle abitudini quotidiane delle persone hanno influito molto sulla loro condizione fisica causando, anche in età relativamente bassa (40 anni), varie problematiche fisiche su muscoli ed articolazioni) Lo scopo di questo impianto è quello di permettere una leggera attività fisica in forma controllata e in modo divertente.

ARGENTOVIVO, wellness area.

Since some decades, the changes in the daily habits of the people have a great influence on their physical condition. This may cause even at a relatively low age (40 years), various physical problems of muscles and joints. The purpose of this system is to allow light physical activity in a controlled manner and in an entertaining way.

Art. 019200
ARGENTOVIVO FULL
Area necessaria 26 mq.
26 sqm. required

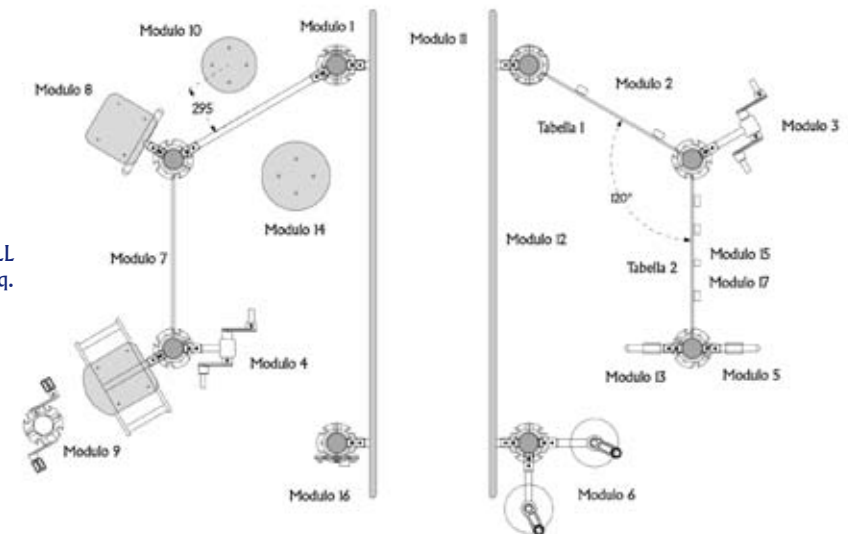

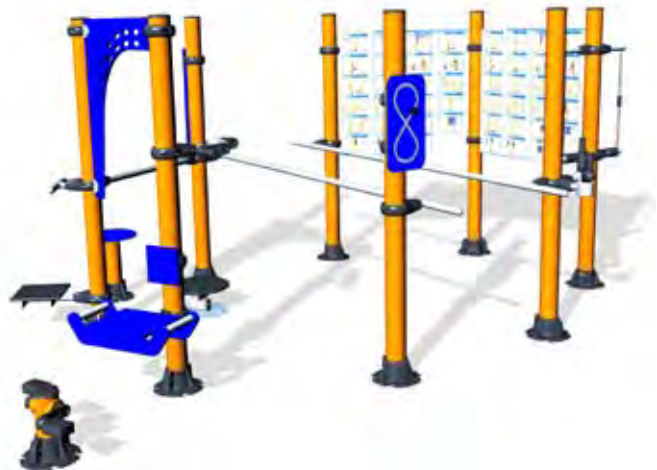

Art. 019200
ARGENTOVIVO FULL
 17 moduli / modules
 39 esercizi / exercises
 20 utilizzatori / users
 2 tabelle / signboards
 Dim: 440x320 h220 cm



Art. 019205
ARGENTOVIVO Compact 1
 16 moduli / modules
 34 esercizi / exercises
 18 utilizzatori / users
 2 tabelle / signboards
 Dim: 430x300 h220 cm



Art. 019210
ARGENTOVIVO Compact 2
 11 moduli / modules
 20 esercizi / exercises
 11 utilizzatori / users
 1 tabella / signboard
 Dim: 220x300 h220 cm

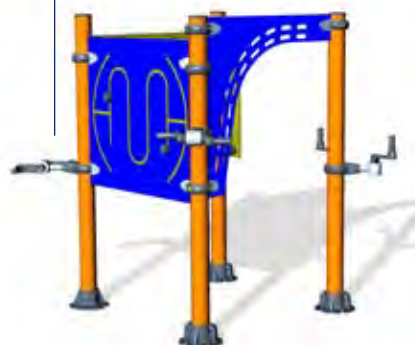

Art. 019215
ARGENTOVIVO Compact 3
 8 moduli / modules
 13 esercizi / exercises
 8 utilizzatori / users
 1 tabella / signboard
 Dim: 220x220 h220 cm



Art. 019220
ARGENTOVIVO Compact 4
 8 moduli / modules
 20 esercizi / exercises
 8 utilizzatori / users
 1 tabella / signboard
 Dim: 150x310 h220 cm

Art. 019225
ARGENTOVIVO Compact 5
 3 moduli / modules
 6 esercizi / exercises
 3 utilizzatori / users
 1 tabella / signboard
 Dim: 70x260 h220 cm



Art. 019230
ARGENTOVIVO Compact 6
 5 moduli / modules
 10 esercizi / exercises
 5 utilizzatori / users
 1 tabella / signboard
 Dim: 70x200 h220 cm





LINEA YOUNG YOUNG LINE

Linea studiata per piccoli e grandi parchi gioco, con struttura realizzata in Abilam.

La linea YOUNG utilizza una struttura in Abilam: elementi di legno bilama spessore 90x90 mm uniti a sezioni contrapposte per garantire un'eccezionale robustezza e durata. Il concetto costruttivo di questi prodotti si basa su un'elevata modularità con la possibilità di creare numerose composizioni per parchi gioco di ogni dimensione. Tutti gli elementi in legno sono sollevati da terra e collegati al terreno mediante staffe in acciaio. Gli scivoli sono disponibili in polietilene riciclabile oppure in acciaio inox. La tinta cromatica di torri e castelli è stata studiata per un inserimento ottimale nelle aree rispettose della natura.

A line which can be fitted in small or large playgrounds, the structure is made of Abilam.

The YOUNG line uses an Abilam structure: two wood elements are joined in opposing sections to thickness 90x90 mm to ensure exceptional strength and durability. The construction concept of these products is based on a high modularity enabling to create many compositions for playgrounds of all sizes. All wood components are raised above the ground and equipped with galvanized brackets. All items of the Young Line are available with slides in polyethylene or stainless steel. The paint color of towers and castles has been studied for an optimal placement in areas respectful of nature.



-10,54
Kg
CO₂

Altalena Singola Young

ART. 015001

308 x 154 h 218 cm

730 x 608 cm

3-11



-10,54
Kg
CO₂

Altalena Singola Secur Young

ART. 015017

308 x 154 h 218 cm

730 x 608 cm

2-5



-11,79
Kg
CO₂

Altalena Doppia Young

ART. 015000

398 x 154 h 218 cm

720 x 700 cm

3-11



-11,79
Kg
CO₂

Altalena Doppia Mix Young

ART. 015002

398 x 154 h 218 cm

720 x 700 cm

2-11



-11,79
Kg
CO₂

Altalena Doppia Secur Young

ART. 015004

398 x 154 h 218 cm

720 x 700 cm

2-5



Attrezzo base per scuole e parchi pubblici. I seggiolini in gomma con anima metallica sono disponibili anche nel modello "a gabbia di sicurezza" per i più piccoli o per utenti diversamente abili. Perni in acciaio inox.

Basic equipment for schools and public parks. Rubber seats with metal core are also available for the safety model "cradle" for younger children and disabled people. Stainless steel fittings.





-11,79
Kg
CO₂

Altalena Cestone Young

ART. 015009

398 x 154 h 218 cm

730 x 695 cm

2-8

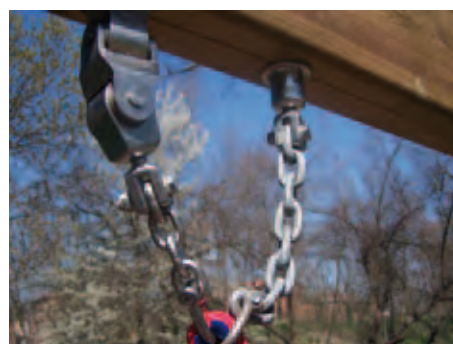

Altalena multiposto: il cestone diametro 100 cm può contenere da 4 a 6 bambini, ed è dotato di perni a doppia sicurezza.

Un gioco comodo e sicuro, anche per i meno abili.

Multi-child swing: the large basket diameter 100 cm can host from 4 to 6 people, and it is equipped with double safety pins. Comfortable and safe playground equipment, also for disabled people.



-8,63
Kg
CO₂

Arrampicata Young

ART. 015003

125 x 195 h 200 cm

400 x 500 cm

3-11



-8,63
Kg
CO₂

Arrampicata Mista Young

ART. 015026

125 x 195 h 200 cm

400 x 500 cm

3-11

Doppia arrampicata disponibile nella versione con due reti, o con una rete e spalliera.

Double climber available in two versions: with two nets or with a net and wall bars



Altalene molto stabili e resistenti con montanti sezione 9x9 cm e traversa in acciaio. Sono disponibili con vari tipi di seggiolino.

Swings very stable and resistant. Wood posts 9x9 cm and steel top. Available with different kind of seats.



-4,42
Kg
CO₂

Altalena Singola Fruts

ART. 016081

254 x 157 h 205 cm

560 x 705 cm

3-8



-4,42
Kg
CO₂

Altalena Singola Secur Fruts

ART. 016082

254 x 157 h 205 cm

560 x 705 cm

2-5





-4,42
Kg
CO₂

Altalena Doppia Fruts

ART. 016083

↕ 344 x 157 h 205 cm

▭ 650 x 705 cm

👤👤 3-8



-4,42
Kg
CO₂

Altalena Doppia Mix Fruts

ART. 016084

↕ 344 x 157 h 205 cm

▭ 650 x 705 cm

👤👤 2-8



-4,42
Kg
CO₂

Altalena Doppia Secur Fruts

ART. 016085

↕ 344 x 157 h 205 cm

▭ 650 x 705 cm

👤👤 2-5



Perni in acciaio inox
Stainless steel fittings



-11,37
Kg
CO₂

Scivolo Giraffa

ART. 016039

ART. 016040 (INOX)

86 x 322 h 279 cm

386 x 672 cm

3-9

Una linea di giochi originali e innovativi, molto decorativi e di grande attrazione per i bambini, dotati di rampa di salita e scivolo in acciaio inox o VTR-PE. Le pareti sono realizzate in polietilene riciclabile, che non richiede manutenzione.

Original and innovative playground equipment line, highly decorative and entertaining, equipped with access ramp and stainless steel or fibreglass-polyethylene slide. Walls are made of recyclable polyethylene, maintenance free.





-11,37
Kg
CO₂

Scivolo Dino

ART. 016028

ART. 016029 (INOX)

86 x 322 h 269 cm

386 x 672 cm

3-9



-10,48
Kg
CO₂

Scivolo Dumbo

ART. 016023

ART. 016024 (INOX)

86 x 322 h 168 cm

386 x 672 cm

3-9

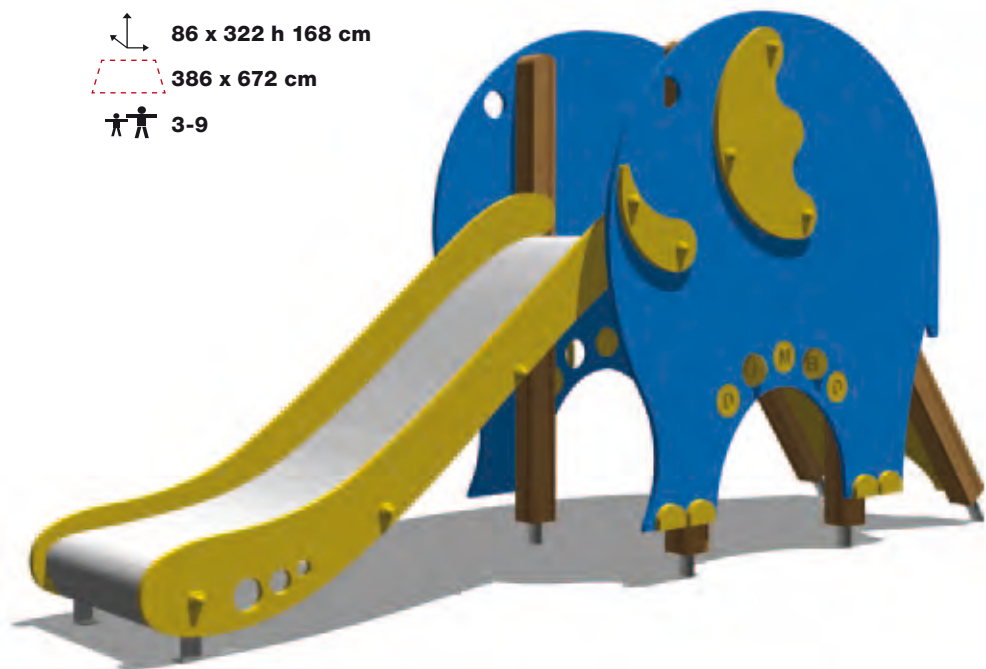

-10,48
Kg
CO₂

Scivolo Riccio

ART. 016018

ART. 016019 (INOX)

86 x 322 h 168 cm

386 x 672 cm

3-9

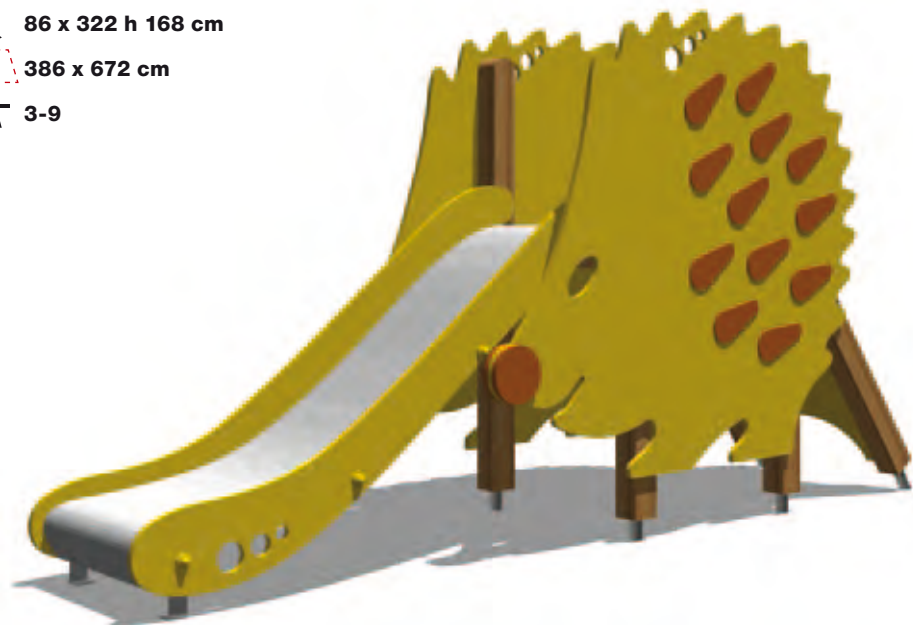

Rampa di salita con appigli facilitati.
Access ramp with handholds.

-10,48
Kg
CO₂

Scivolo Fungo

ART. 016026

ART. 016027 (INOX)

86 x 322 h 175 cm

386 x 672 cm

3-9

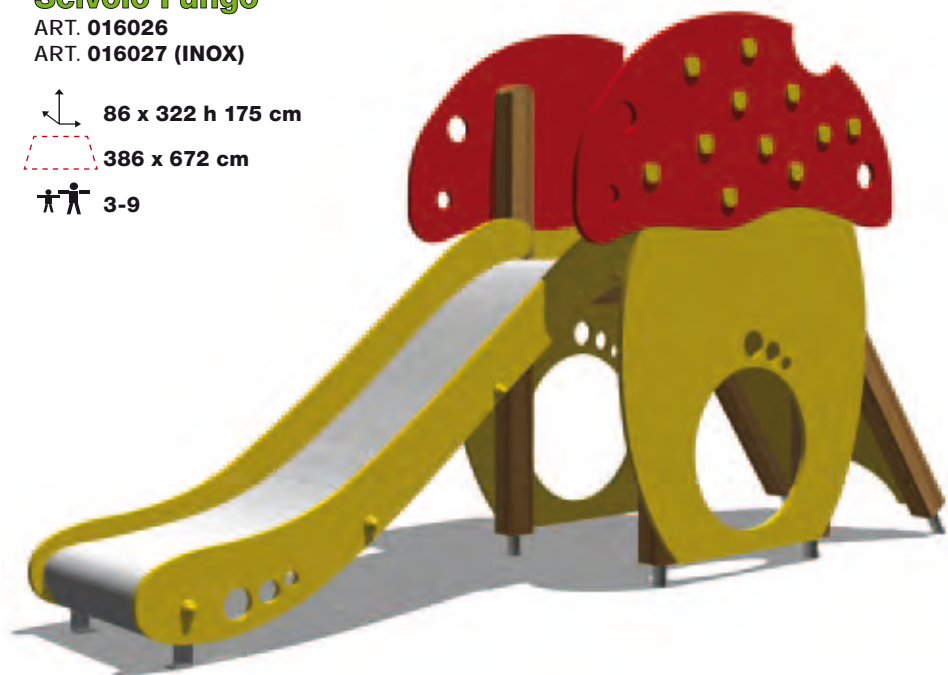

-10,48
Kg
CO₂

Scivolo Polpo

ART. 016037

ART. 016038 (INOX)

86 x 322 h 169 cm

386 x 672 cm

3-9

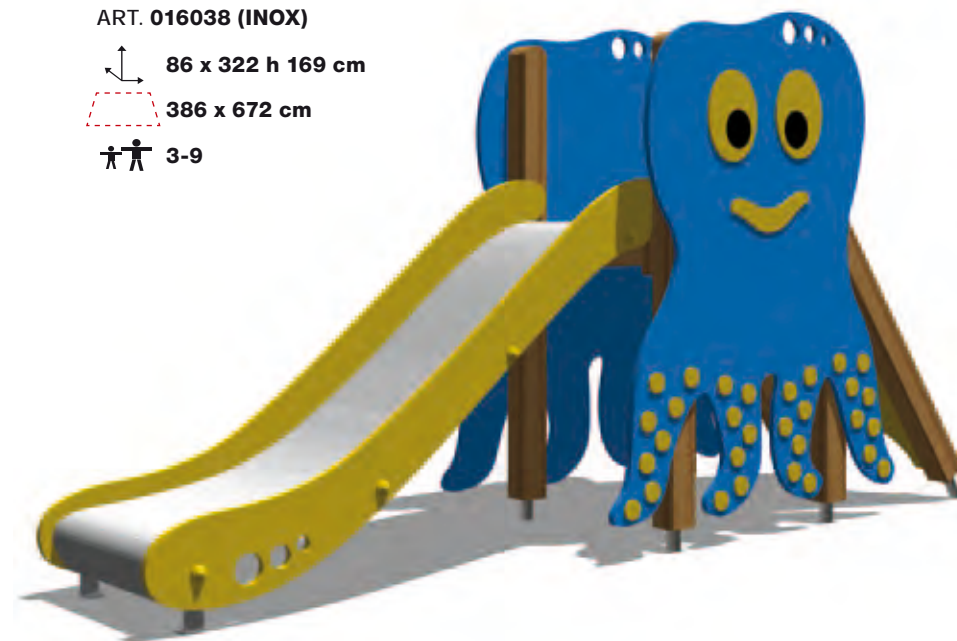

-34,27
Kg
CO₂

Pista Baby Sprint

ART. 016087

2500 cm (Lunghezza totale percorso)

1100 x 1122 cm

2-8

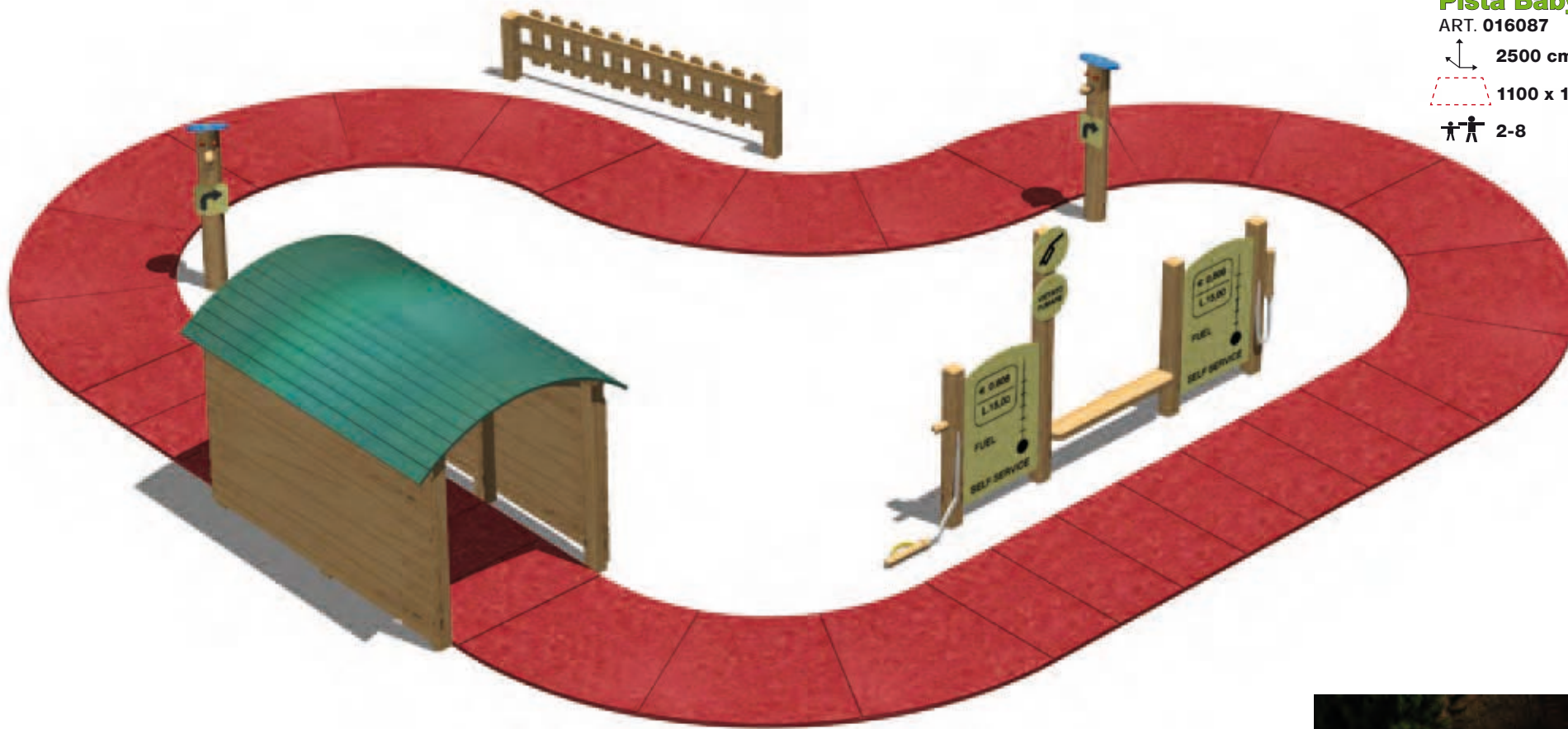

Stazione pompa benzina

- 6,85
Kg
CO₂

ART. 016094

14 x 270 h 164 cm

2-8



Pista per tricicli e biciclette, realizzata in piastre di gomma riciclata spessore 35 mm. Completa di vari accessori per il gioco di ruolo e la socializzazione: tunnel, area di rifornimento, recinzione e tre omini-vigile con segnali stradali. Lunghezza del percorso 25 metri.

Tricycle and bicycle track, made of recycled rubber tiles thickness 35 mm.

Includes a complete set of accessories for role playing and socialization: tunnel, petrol station, fencing and three traffic-policeman characters with road signs.

Track length 25 meters.





- 1,99
Kg
CO₂

Vigile

ART. 016093

Ø 16 x H 113 cm

150 x 150 cm

2-8

- 39,07
Kg
CO₂

Pista Baby Sprint Maxi

ART. 016088

4000 cm (Lunghezza totale percorso)

1346 x 1372 cm

2-8

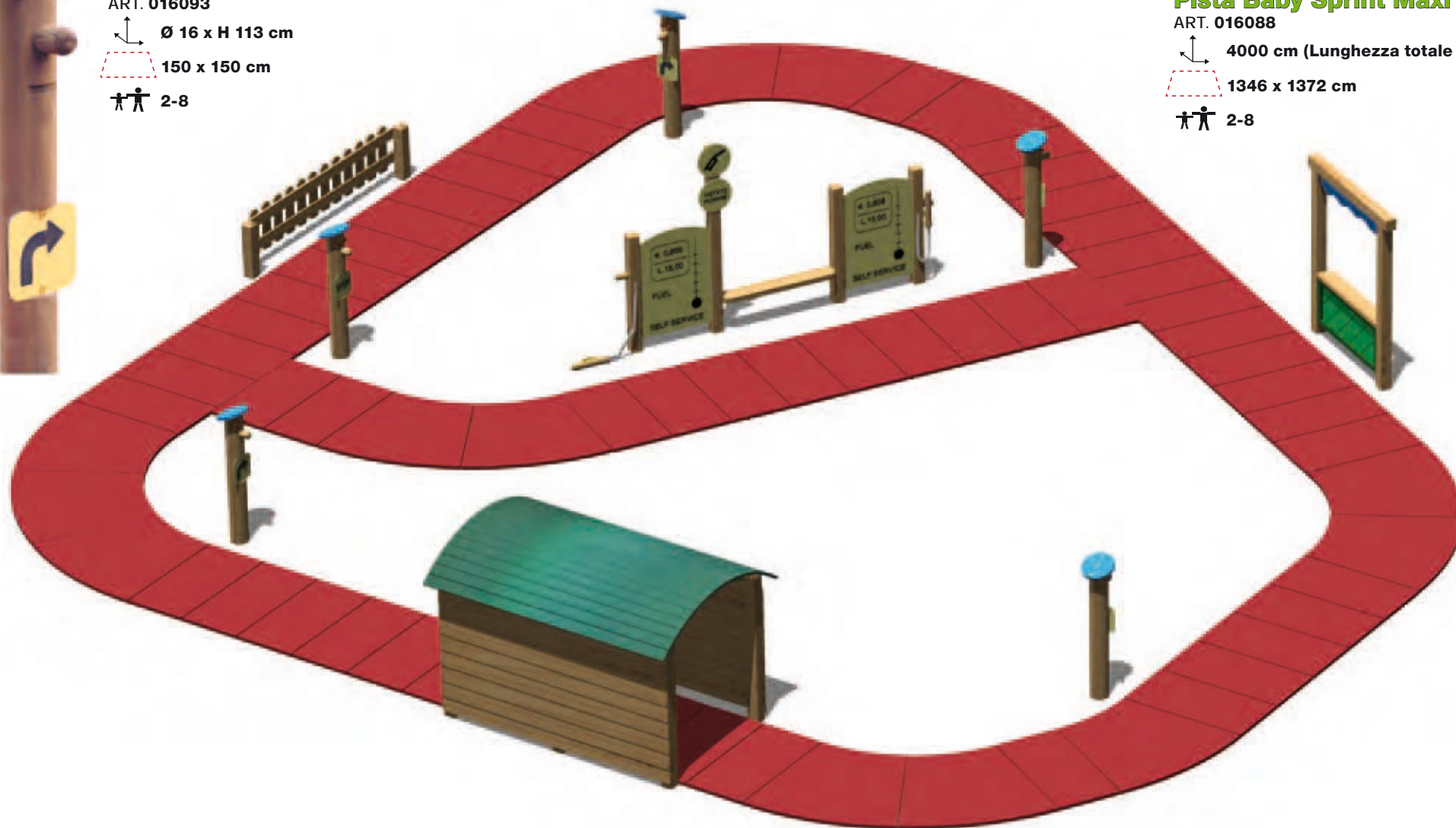

Grande pista per tricicli e biciclette, realizzata in piastre di gomma riciclata spessore 35 mm. Completa di vari accessori per il gioco di ruolo e la socializzazione: tunnel, area di rifornimento, recinzione, teatrino e cinque omni-vigile con segnali stradali. Lunghezza del percorso 40 metri.

Large tricycle and bicycle track, made of recycled rubber tiles thickness 35 mm. Includes a complete set of accessories for role playing and socialization: tunnel, petrol station, fencing, theatre and five traffic-policeman characters with road signs. Track length 40 meters.



Palestre multifunzione composte da:
 rete di arrampicata, spalliera svedese,
 pertica, sbarra volteggio, fune di salita e sbarra
 alta per trazioni. La versione "Climb" ha una
 parete di arrampicata con appigli facilitati.

Multifunction gyms made of:
 climbing net, wall bars, climbing pole,
 horizontal bar, climbing rope and pull bar.
 The "Climb" version has a climbing wall
 with helping pegs.

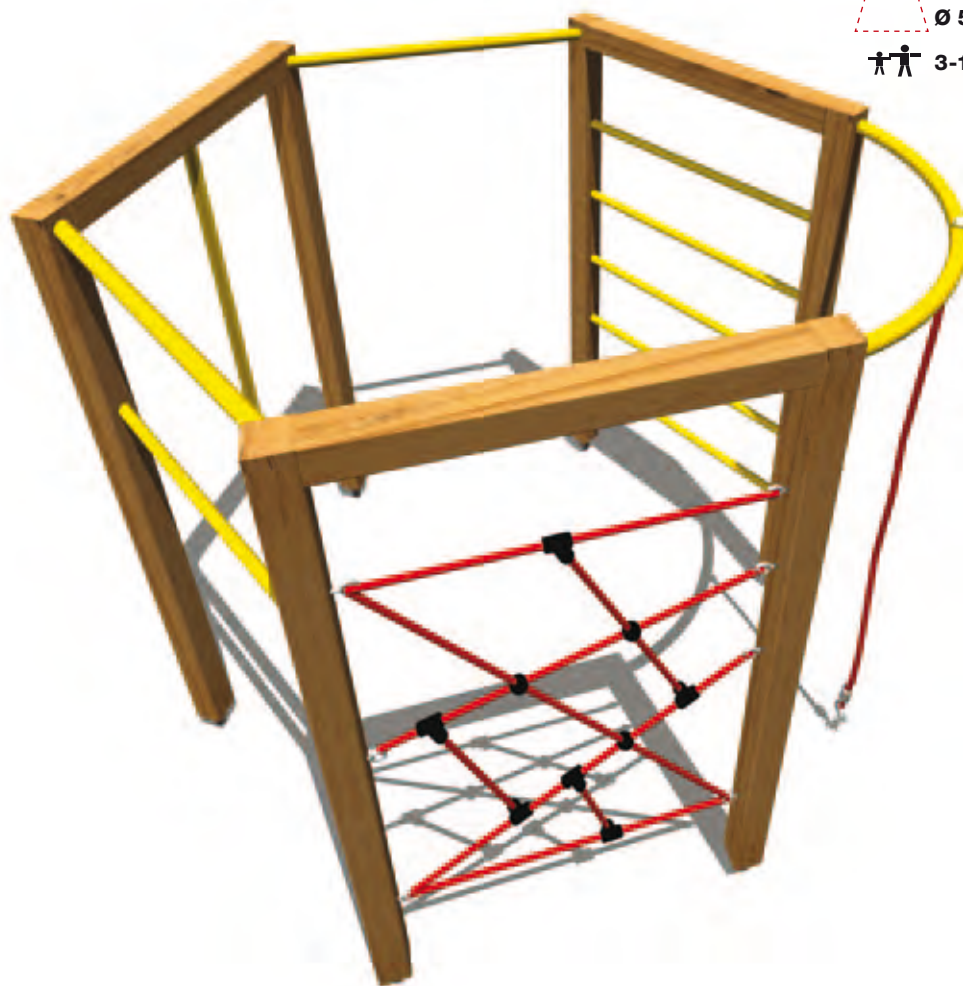

Palestra Esagonale Young

ART. 015006

↓ Ø 230 x h 209 cm

∅ 580 cm

3-11

-13,68
Kg
CO₂



Palestra Esagonale Young Climb

ART. 015019

↓ 222 x 192 h 209 cm

∅ 580 cm

3-11

-17,93
Kg
CO₂

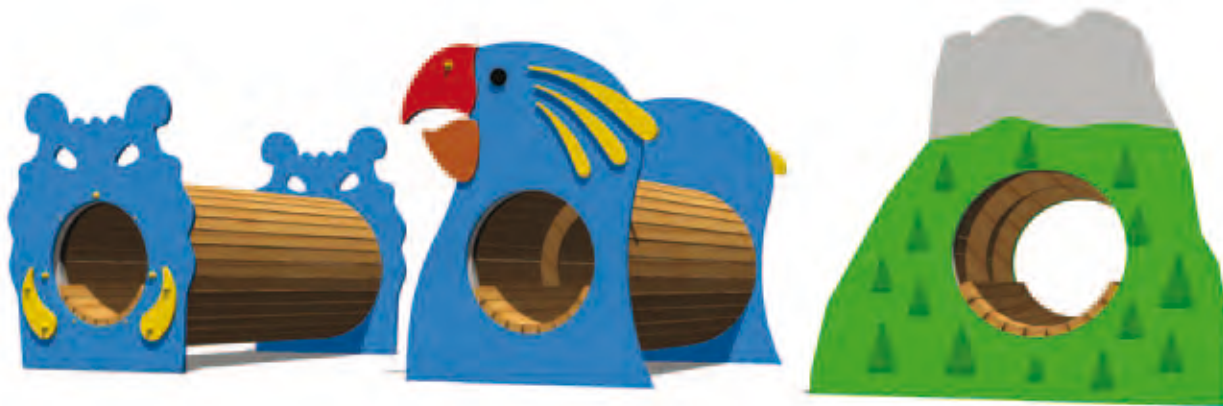

Tunnel figurativi con o senza le vivaci pareti di ingresso che offrono una dimensione di fantasia al gioco. Sono personalizzabili “a tema”.

Tunnels with or without the colorful entry walls that add a dimension of fantasy to the game. Can be customized by “theme”.

-25,96
Kg
CO₂

Tunnel Pumbaa

ART. 015041

119 x 199 h 139 cm

419 x 499 cm

2-11

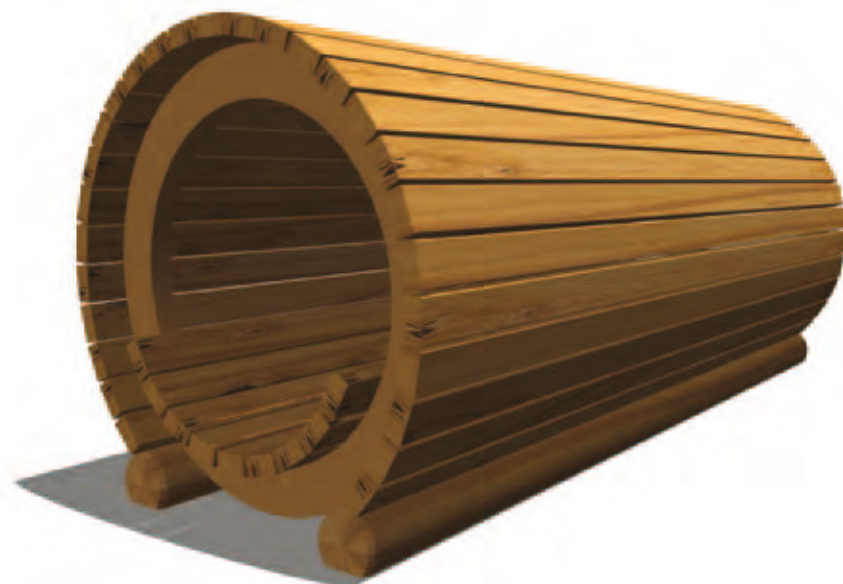

-23,94
Kg
CO₂

Tunnel Young 200

ART. 015011

87x 200 h84 cm

387 x 495 cm

3-11





Scivoli con accesso mediante scala a pioli.
 Altezze da terra 100 oppure 150 cm.
 Slides with access by a pegs ladder.
 High above the ground 100 or 150 cm.



Scivolo Nube 100

ART. 015091

70 x 230 h 180 cm

360 x 556 cm

2-9

-3,22
Kg
CO₂



Scivolo Nube 150

ART. 015092

70 x 310 h 230 cm

360 x 636 cm

2-11

-4,10
Kg
CO₂

Scivolo con partenza a 150 cm da terra, scala a gradini con corrimano. Parapetti e sponde scivolo in polietilene, pista di scorrimento in VTR.

Slide with platform at 150 cm above the ground, staircase with handrails. Parapets and barriers of the slide in polyethylene, sliding tracks in VTR.

Scivolo Aria

ART. 015094

78 x 396 h 225 cm

375 x 694 cm

2-11

-11,23
Kg
CO₂





-5,62
Kg
CO₂

Pannello Figurativo

ART. 015024

115 x 9 h 120 cm

315 x 209 cm

2-14

-3,84
Kg
CO₂

Lavagna per l'Esterno

ART. 015023

140 x 9 h 120 cm

340 x 209 cm

2-14

-5,62
Kg
CO₂

Pannello Tris

ART. 015025

115 x 9 h 120 cm

315 x 209 cm

2-14



Pannelli modulari. Possono essere utilizzati da soli o come integrazione di torri e castelli.

Modular panels. They can be employed independently or as add-on for towers and castles.



Divertente specchio deformante in acciaio inox.
Può essere inserito anche in casette, torri e castelli.

Amusing stainless steel deforming mirror.
Can be also integrated in huts, towers and castles.

-5,00
Kg
CO₂

Specchio Magico

ART. 015022

110 x 14 h 120 cm

314 x 410 cm

2 in sù



Disco rotante con labirinto interno, per lo sviluppo dell'abilità visiva e motoria.

Il pannello modulare può essere utilizzato da solo o abbinato ad altri giochi

Rotating disc with internal labyrinth, promotes visual and motor skills.

The modular panel can be employed independently or as add-on for other playground equipment.

-4,75
Kg
CO₂

Gioco dell'Euro

ART. 015029

114 x 9 h 120 cm

309 x 410 cm

2 in sù





Labirinti modulari componibili, realizzati sulla base di quattro tipi di pannelli-parete. E' possibile inserire nelle composizioni (optional): lavagne, pannelli figurativi, gioco dell'Euro e specchi magici.

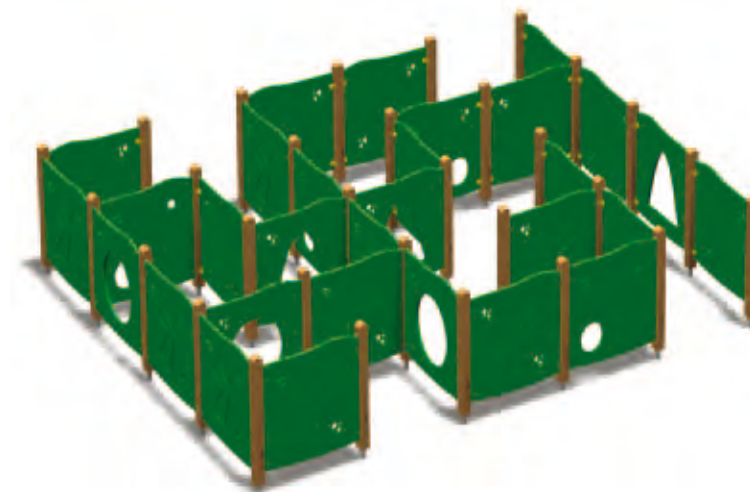

Modular labyrinths, based upon four kind of wall-panels. It is possible to integrate the compositions with the following optional equipment: blackboards, figurative panels, Euro currency game and magic mirrors.

Pannelli per Labirinto

Labirinto Young Grande

ART. 015033

535 x 430 h 120 cm

835 x 730 cm

2 in sù

-6,14
Kg
CO₂

Labirinto Young Medio

ART. 015032

430 x 325 h 120 cm

730 x 625 cm

2 in sù

-6,14
Kg
CO₂

Labirinto Young Piccolo

ART. 015031

325 x 325 h 120 cm

625 x 625 cm

2 in sù

-6,14
Kg
CO₂

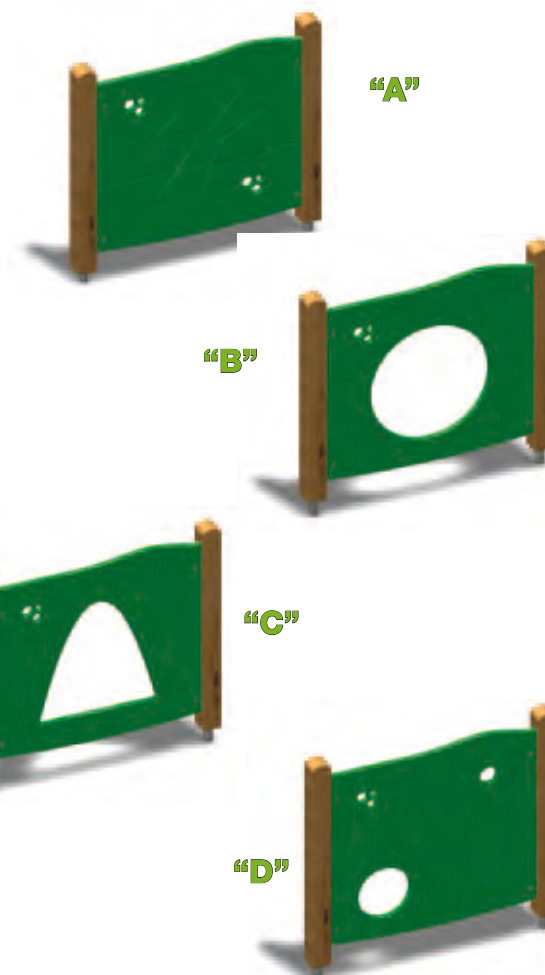
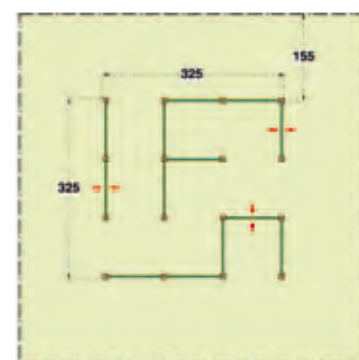
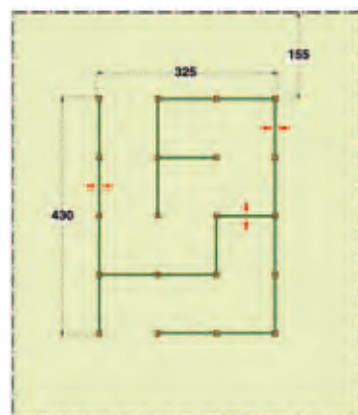
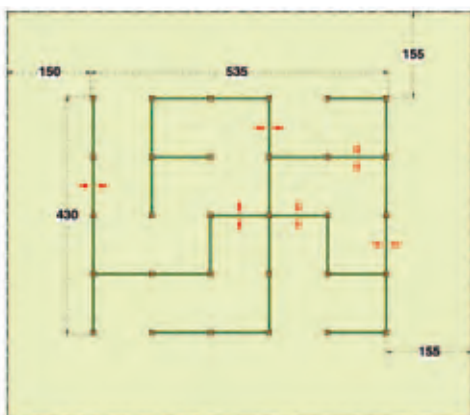



Gioco figurativo realizzato interamente in legno, completo di piccola rampa, tunnel e panchetta interna.

Figurative playground equipment entirely made of wood, includes small ramp, tunnel and internal bench.



-67,32
kg
CO₂

Locomotiva Young

ART. 015014

145 x 365 h 200 cm

445 x 665 cm

2-11





-22,45
Kg
CO₂

Casetta Midi

ART. 015007

130 x 130 h 215 cm

425 x 425 cm

2-11

Casette con arredo interno, collegabili con tunnel e pedane per creare "villaggi" dei bambini.

Huts complete with furniture that can be connected through tunnels and step boards to form children "villages".

81,80
Kg
CO₂

Casetta Esagonale Young

ART. 015018

271 x 358 h 293 cm

660 x 570 cm

2-11



Ampia casetta con pareti attrezzate:
specchio magico, pannelli figurativi e rampetta
per l'accesso agli utenti con particolari necessità.

Large hut with well-equipped walls: magic mir-
ror, figurative panels and board for access to
users with special needs.





-31,65
Kg
CO₂

Stegosaurus Poly

ART. 015048

522 x 490 h 280 cm

822 x 824 cm

3-11



-31,65
Kg
CO₂

Stegosaurus

ART. 015046

522 x 462 h 280 cm

822 x 805 cm

3-11





-31,65
Kg
CO₂

Balena

ART. 015051

515 x 452 x h 260 cm

810 x 822 cm

3-11

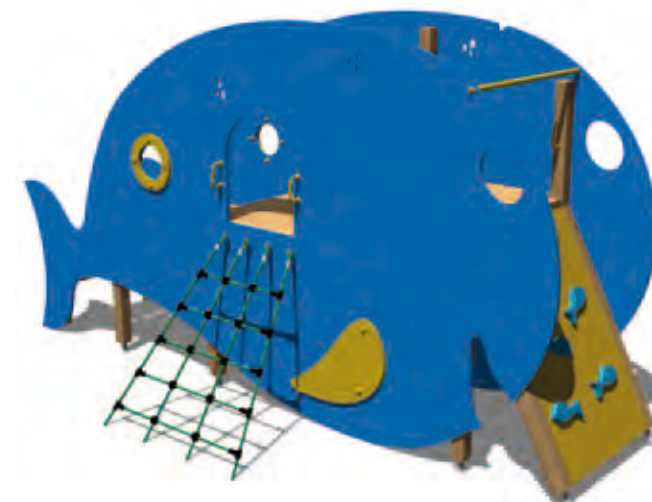
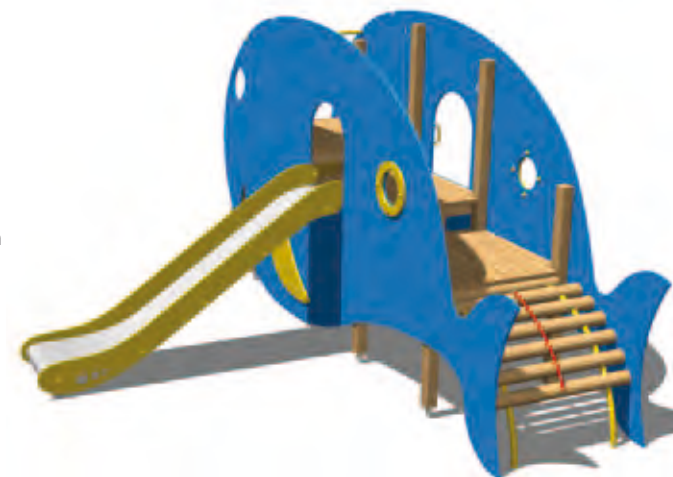

Esclusivi giochi tematici multifunzione, di grande richiamo, composti da tre ponti di camminamento, scivolo, due pareti di arrampicata, rampa curva e rete di arrampicata. Le pareti sono realizzate in polietilene riciclabile spessore 20 mm resistente ai raggi UV, che non richiede manutenzione.

Exclusive multifunction thematic playgrounds equipments, highly entertaining, made of three walking bridges, slide, two climbing walls, curved ramp and climbing net. UV-resistant recyclable polyethylene panels thickness 20 mm, maintenance free.

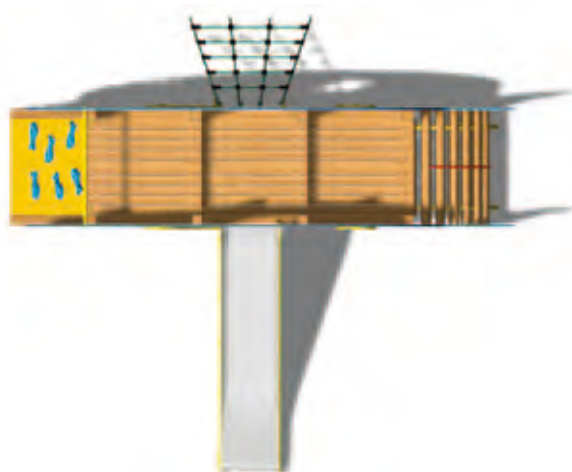

Su ordinazione si possono fornire anche colori diversi. Il gioco comprende palestre di arrampicata con appigli facilitati, per i più piccoli.

Different combinations can be supplied on demand. The playground equipment includes climbers with helping pegs, for younger children.



Ponte Oscillante Young

ART. 015148

270 x 114 h 110 cm

570 x 414 cm

2-12

-11,25
Kg
CO₂



Gioco che stimola coordinamento e concentrazione: passaggio su pioli oscillanti, assistiti da un robusto corrimano.

Game that stimulates coordination and concentration: alley made of swivelling pegs and a sturdy handrail.

FOGLIE - LINEA YOUNG



Queste strutture modulari consentono di dare un taglio “avventuroso” alle attività di gioco mediante passaggi nuovi e audaci come piace agli esigenti bambini d’oggi. Nella fase progettuale è stato considerato anche l’esercizio fisico, importante ed immancabile fattore di benessere per i bambini.

Modular structures which allow “adventurous” activities as the discerning kids of today like it. In the design phase was also considered exercise, important and inevitable element of welfare for children.





Torre Scricciolo

ART. 015500 scivolo PE
ART. 015501 scivolo INOX

-20,50
Kg
CO₂

310 x 212 h 320 cm

cm 630 x 550

1-9



Tutti i giochi della linea Young sono disponibili con scivolo in Polietilene oppure in acciaio INOX.

All items of the Young Line are available with slides in polyethylene or stainless steel.



Torre Cincia

ART. 015505 scivolo PE
ART. 015506 scivolo INOX

-22,30
Kg
CO₂

150 x 355 h 240 cm

cm 450 x 730

2-12



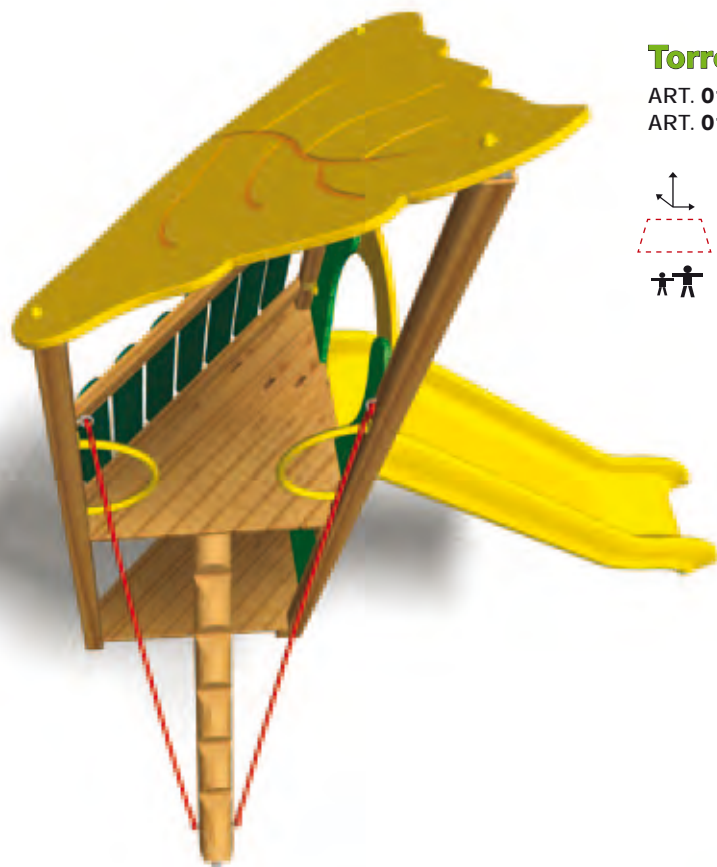

Torre Gazza

-23,76
Kg
CO₂

ART. 015510 scivolo PE
ART. 015511 scivolo INOX

360 x 240 h 345 cm

cm 750 x 530

3-12

Tutti i giochi della linea Young sono disponibili con scivolo in Polietilene oppure in acciaio inox

All items of the Young Line are available with slides in polyethylene or stainless steel.



Torre Civetta

-35,50
Kg
CO₂

ART. 015515 scivolo PE
ART. 015516 scivolo INOX

360 x 245 h 345 cm

cm 750 x 550

3-12

Torri su più livelli, accessibili attraverso una classica scala a gradini oppure per mezzo di sistemi più "avventurosi" che offrono comunque la necessaria sicurezza.

Towers on different levels, accessible through a classical scale step or by more "adventurous" systems that offer anyway the necessary security.





Castello Falco -45,36
Kg
CO₂

ART. 015530 scivolo PE
ART. 015531 scivolo INOX

↕ 515 x 430 h 345 cm

▭ cm 850 x 850

👤 2-12

Castello a due torri con ponte oscillante, scivolo e scaletta a gradini. Il ponte può anche essere dotato di pedana per facilitare l'accesso ai più piccoli.

Two-towered castle with swinging bridge, slide and ladder with steps. The bridge can also be equipped with a platform to facilitate the access for small children.



Castello Airone

-58,36
Kg
CO₂

ART. 015535 scivolo PE

ART. 015536 scivolo INOX

 515 x 460 h 345 cm

 cm 850 x 850

 3-12

Castello con esclusivo ponte su funi. Il passaggio molto divertente ed "avventuroso" è facilitato grazie alla presenza di una pedana di sicurezza.

Castle with exclusive rope bridge. The crossing is very funny and adventurous, facilitated by the presence of a safety platform.





Castello Aquila -82,20
Kg
CO₂
 ART. 015540 scivolo PE
 ART. 015541 scivolo INOX

 515 x 460 h 345 cm

 cm 850 x 850

 3-12





Castelli multi-torre con accessi e passaggi dal taglio "avventuroso". L'irresistibile sfida è quella di raggiungere la torre più alta con passaggi divertenti, diversi e sicuri.

Multi tower castles with adventurous accesses and passages. The irresistible challenge is to reach the highest tower across different, safe and fun passages

Castello Grifone

-109,6
Kg
CO₂

ART. 015545 scivolo PE
ART. 015546 scivolo INOX

520 x 880 H 400 cm

cm 850 x 1250

3-12



Torretta Sciattolo 100

ART. 015560 scivolo PE
ART. 015561 scivolo INOX

-16,98
Kg
CO₂

 331 x 78 h 178cm

 675 X 375 cm

 2-8

Scivoli con scaletta a gradini, adatta anche ai più piccoli, disponibili con altezza da terra di 100 oppure 150 cm.

Slides with ladder, ideal also for younger children, available in 100 or 150 cm height above the ground.



Torretta Sciattolo 150

ART. 015565 scivolo PE
ART. 015566 scivolo INOX

-22,22
Kg
CO₂

 446 x 78 h 228 cm

 800 x 375 cm

 2-12





Torri con scivolo e piani di gioco posti a 15 - 150 e 200 cm da terra, raggiungibili attraverso comode scale a gradini adatte anche ai più piccoli.

Towers with a slide and game platforms at 15 to 150 and 200 cm above the ground, reachable with staircase with steps, suitable even for the smallest.



Torre Lontra 150

ART. 015570 scivolo PE
ART. 015571 scivolo INOX

-46,56
Kg
CO₂

482 x 152 h 398 cm

825 x 425 cm

2-12



Torre Lontra 200

ART. 015590 scivolo PE
ART. 015591 scivolo INOX

-62,08
Kg
CO₂

597 x 152 h 458 cm

950 x 500 cm

3-12





-86,61
Kg
CO₂

Torre Lontra Spyr

ART. 015595

506 x 193 h458 cm

825 X 525 cm

2-12

Torre con tetto, scala a gradini e grande scivolo a spirale con partenza posta a 200 cm da terra.

Tower with a roof, staircase steps and the slide spiral starting at 200 cm above the ground.



Torre Volpe

ART. 015575 scivolo PE

ART. 015576 scivolo INOX

-35,15
Kg
CO₂

425 x 195 h 398 cm

775 x 500 cm

3-12



Torre Lince

ART. 015580 scivolo PE

ART. 015581 scivolo INOX

-36,84
Kg
CO₂

492 x 188 h 398 cm

825 x 475 cm

3-12



Torri con tetto, scivolo e piani di gioco a 15 e 150 cm da terra raggiungibili attraverso particolari sistemi di accesso che richiedono equilibrio e motricità.

Towers with roof, slide and platforms at 15 and 150 cm above the ground reached through special access systems that require balance and motoricity.

Torre Lupo

ART. 015585 scivolo PE

ART. 015586 scivolo INOX

-34,05
Kg
CO₂

473 x 152 h 398 cm

825 x 425 cm

3-12





Torre Daino

53,83
Kg
CO₂

ART. 015600 scivolo PE
ART. 015601 scivolo INOX

↕ 482 x 505 h 398 cm

▭ 825 x 625 cm

👤 2-12



Torre Cervo

-55,05
Kg
CO₂

ART. 015605 scivolo PE
ART. 015606 scivolo INOX

↕ 482 x 368 h 398 cm

▭ 825 X 725 cm

👤 2-12



Torre Renna

ART. 015610 scivolo PE
ART. 015611 scivolo INOX

62,53
Kg
CO₂

721 x 482 h 398 cm

925 x 825 cm

2-12



Torri con tetto, scivolo e piani di gioco posti a 15 e 150 cm da terra, dotate di altalena e/o palestra multi-funzione.

Towers with roof, slide and 2 platforms at 15 and 150 cm above the ground, with a swing and/or multi-functional gym.

Tutti i giochi della linea Young sono disponibili con scivolo in Polietilene oppure in acciaio INOX.

All items of the Young Line are available with slides in polyethylene or stainless steel.





Torre Martora

-41,91
Kg
CO₂

ART. 015620 scivolo PE
ART. 015621 scivolo INOX

↕ 260 x 310 h348 cm

▭ 575 x 650 cm

🧑 2-9



Doppie torri multifunzione con piani di gioco a 100 cm da terra ed estensioni (palestra - altalena).

Multifunction double towers with playing platform at 100 cm above the ground and extensions (gym - swing).

Torre Marmotta

ART. 015625 scivolo PE
ART. 015626 scivolo INOX

-52,14
Kg
CO₂

663 x 261 h 348 cm

825 x 675 cm

2-9



Torre Faina

ART. 015630 scivolo PE
ART. 015631 scivolo INOX

-50,62
Kg
CO₂

525 x 260 h 348 cm

925 x 575 cm

2-9





Torre multifunzione ideale per il gioco attraverso l'attività fisica dell'arrampicata, completa di scivolo (PE oppure INOX)

Multifunction tower, ideal for playing through the physical activity of climbing and with a slide (PE or INOX)

Torre Puma

ART. 015640 scivolo PE
ART. 015641 scivolo INOX

-36,50
Kg
CO₂

↕ 420 x 351 h 228 cm

▭ 750 x 775 cm

👤 3-12



Torre Castoro

ART. 015645 scivolo PE

-38,87
Kg
CO₂

351 x 284 h 278 cm

775 x 600 cm

3-12

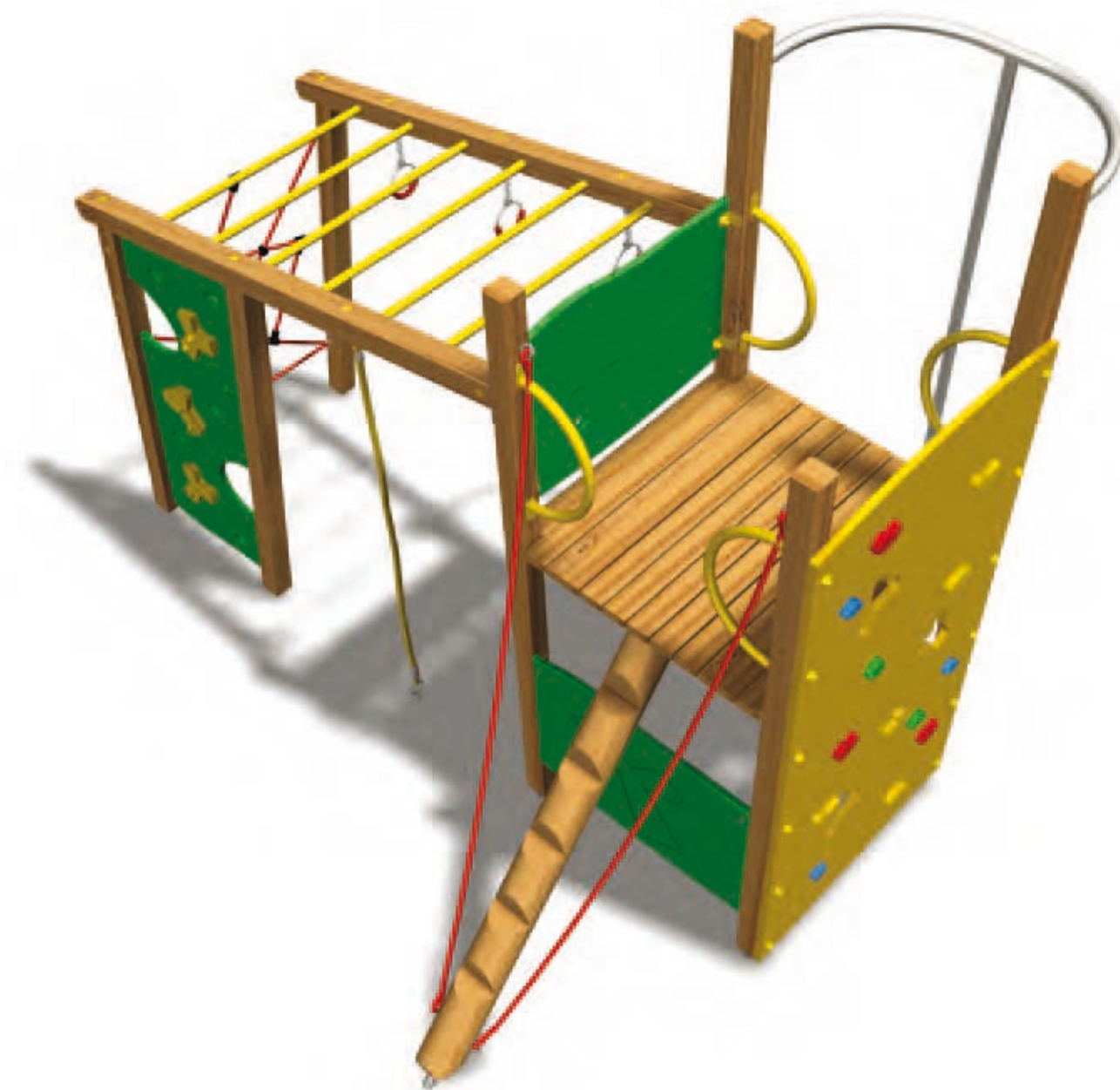

Torre multifunzione ideale per il gioco attraverso l'attività fisica dell'arrampicata.

Multifunction tower, ideal for playing through the physical activity of climbing.





Castello Alice

-54,42
Kg
CO₂

ART. 015635 scivolo PE

ART. 015636 scivolo INOX

↕ 671 x 250 h 398 cm

▭ 1000 x 550 cm

👤 3-12



Castello a due torri con ponte Tibetano, scivolo, scaletta su dischi e scaletta a pioli.
Two towers castle with Tibetan bridge, slide and ladders on discs and pegs.



Castello Oasi

-82,81
Kg
CO₂

ART. 015650 scivolo PE

ART. 015651 scivolo INOX

↕ 603 x 378 h 398 cm

▭ 900 x 700 cm

👤 2-12



Castello a due torri con ponte fisso, scivolo e facile scaletta a gradini.
Two towers castle with fixed bridge, slide and ladder with easy steps.

Castello Pampa

ART. 015660 scivolo PE
ART. 015661 scivolo INOX

-68,45
Kg
CO₂

513 x 378 h 398 cm

800 x 700 cm

3-12



Castello a due torri con esclusivo tunnel in rete,
scivolo, parete climb e scaletta a pioli.

Two-towered castle with an exclusive net-tunnel,
slide, climbing wall and ladder on pegs.



Castello Selva

ART. 015670 scivolo PE
ART. 015671 scivolo INOX

-74,11
Kg
CO₂

598 x 378 h 398 cm
875 x 700 cm

3-12



Castello Pineta

ART. 015680 scivolo PE
ART. 015681 scivolo INOX

-76,39
Kg
CO₂

588 x 378 h 398 cm
875 x 700 cm

2-12

I ponti oscillanti possono essere forniti con pedana di sicurezza.

All swinging bridges can be provided with safety platform.



Castello Bosco

ART. 015685 scivolo PE
ART. 015686 scivolo INOX

-85,09
Kg
CO₂

588 x 593 h 398 cm

1000 x 950 cm

2-12



Tutti i giochi della linea Young sono disponibili con scivolo in Polietilene oppure in acciaio inox

All items of the Young Line are available with slides in polyethylene or stainless steel.

-81,63
Kg
CO₂

Castello Foresta

ART. 015690 scivolo PE
ART. 015691 scivolo INOX

813 x 721 h 398 cm

1175 x 900 cm

2-12

Castello multi-torre con diversi sistemi di accesso e transito, studiati non solo per il gioco, ma anche per lo sviluppo della coordinazione motoria.

Multi-tower castle with different access and passages, designed not only for the game, but also for the development of motoric coordination.



Tutte le componenti in legno sono sollevate da terra e dotate di staffa zincata.

All wood components are raised from the ground and equipped with galvanized brackets.



114,67
Kg
CO₂

Castello Tundra

ART. 015700 scivolo PE
ART. 015701 scivolo INOX

↕ 625 x 813 h 398 cm

▭ 1150 x 900 cm

👤 3-12



Tutti i giochi della linea Young sono disponibili con scivolo in Polietilene oppure in acciaio INOX.

All items of the Young Line are available with slides in polyethylene or stainless steel.

-134,27
Kg
CO₂

Castello Prateria

ART. 015710 scivolo PE
ART. 015711 scivolo INOX

971 x 883 h 398 cm

1375 x 1000 cm

2-12

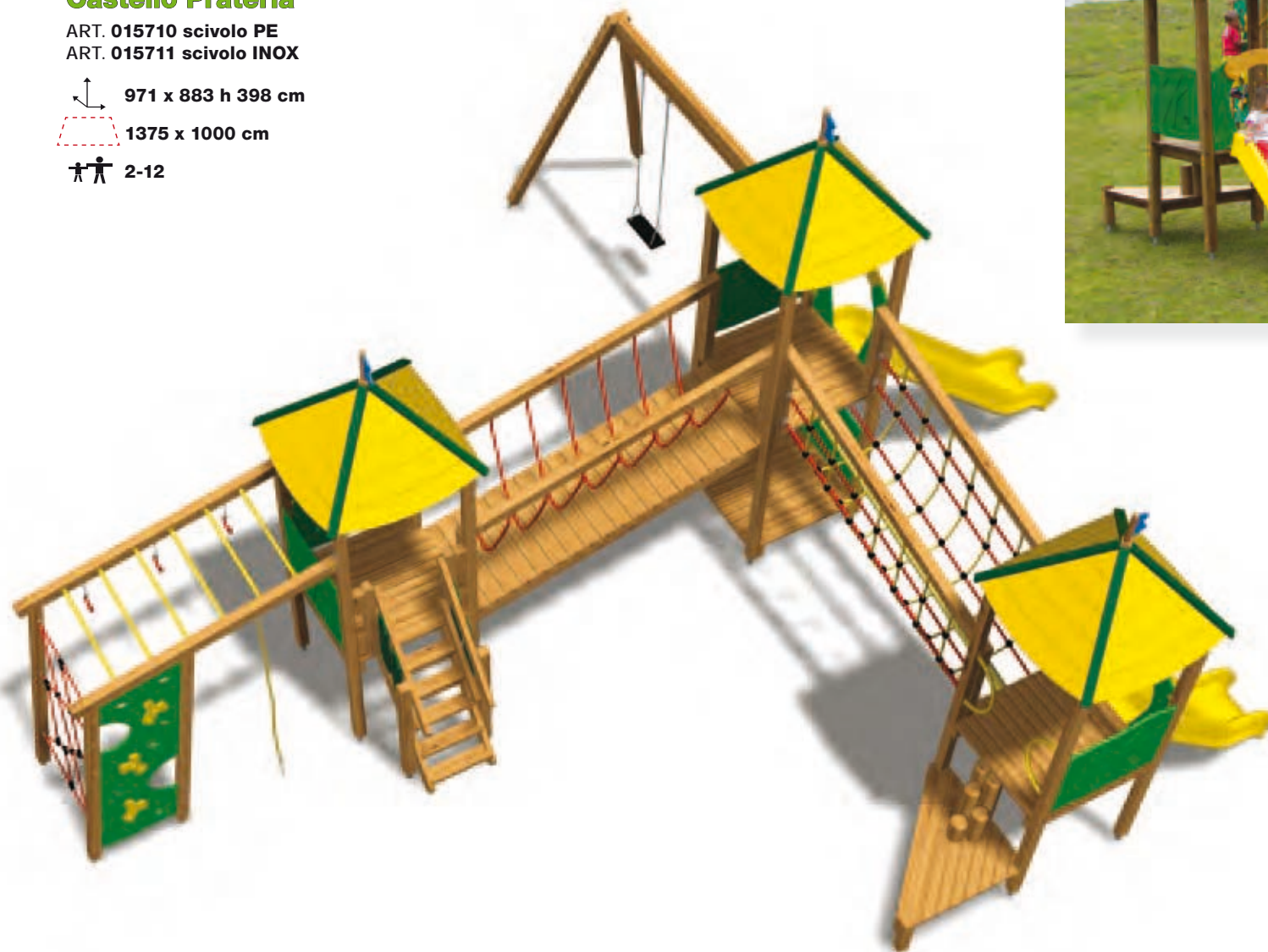

Castelli multi-torre dotati di vari tipi di accesso, ponti sospesi e scivoli da diverse altezze.

Multi-tower castles equipped with various types of access, suspension bridges and slides of different heights.

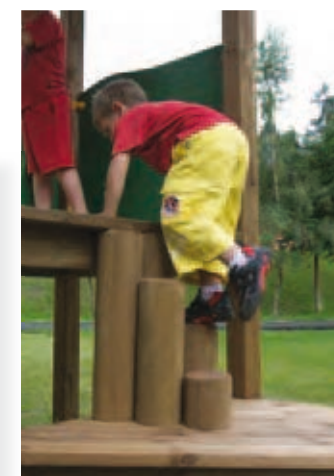
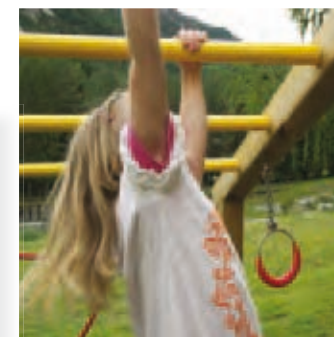

-185,98
Kg
CO₂

Castello Savana

ART. 015720 scivolo PE

ART. 015721 scivolo INOX

 1030 x 1033 h 398 cm

 1350 x 1200 cm

 2-12

Tutti i giochi della linea Young sono disponibili con scivolo in Polietilene oppure in acciaio INOX.

All items of the Young Line are available with slides in polyethylene or stainless steel.

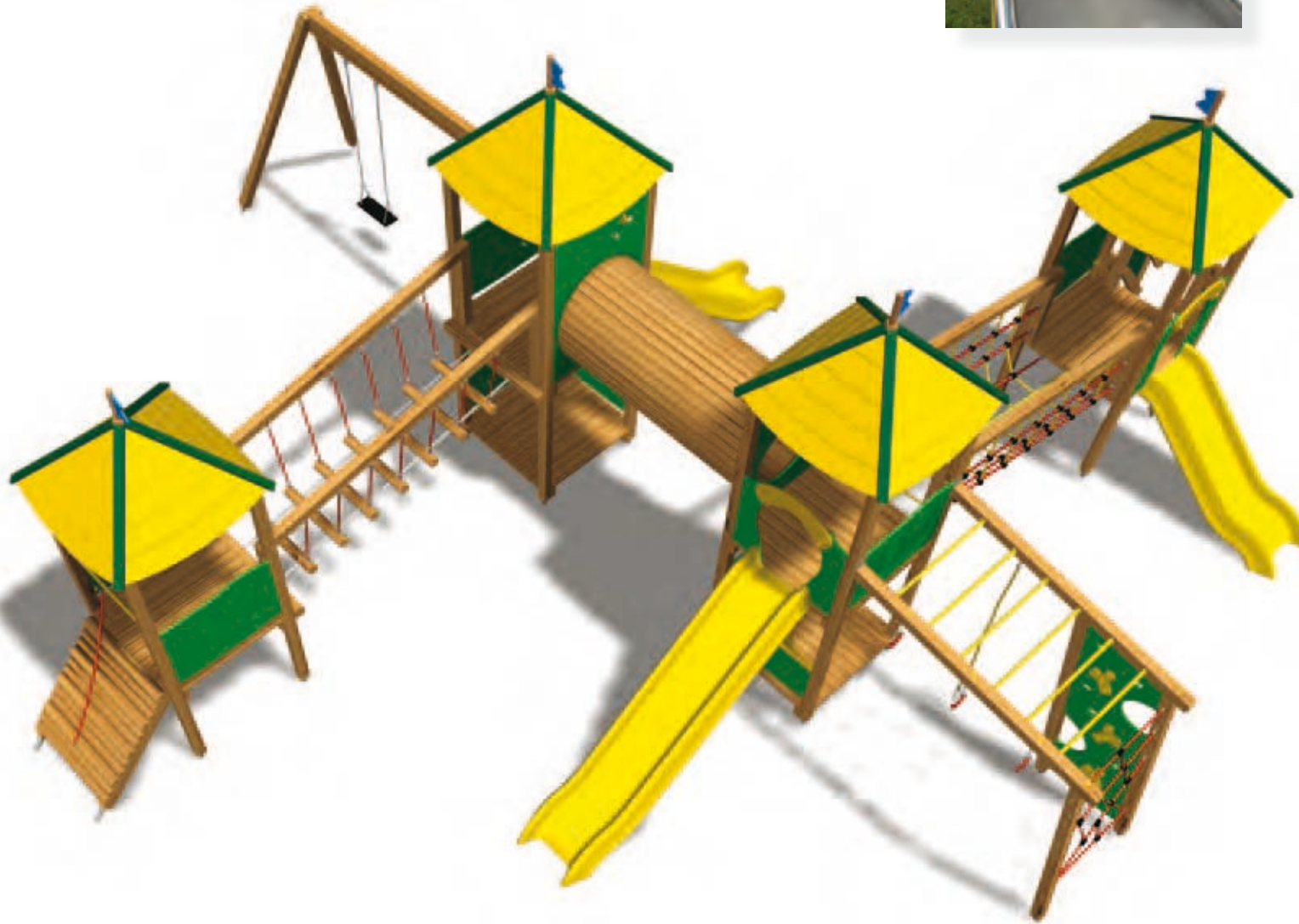



-117,20
Kg
CO₂

Castello Dolomiti

ART. 015730 scivolo PE

ART. 015731 scivolo INOX

689 x 686 h 470 cm

1075 x 1000 cm

3-14

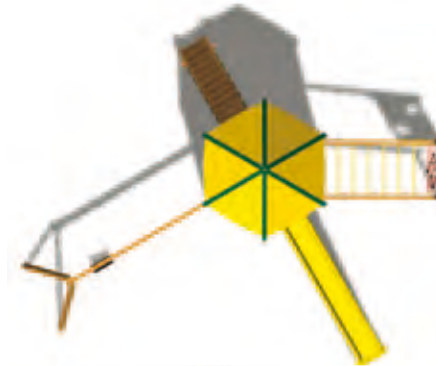

Grande castello multifunzione con tanto spazio per il gioco e la socializzazione. Comprende scala a gradini, palestra, scivolo H 200, altalena, pannello figurativo e due piani di gioco posti a 20 e 200 cm da terra.

Big castle with lots of space for playing and socialization. Includes stairs, gym, slide H 200, swing, figured panels and two game platforms at 20 and 200 cm from the ground.



-138,15
Kg
CO₂

Castello Alpi

ART. 015735 scivolo SPYR

631 x 749 h 470 cm

975 x 1175 cm

3-14



Grande castello d'avventura con due torri collegate da un ponte su funi. L'accesso avviene mediante: sartia, parete climbing e tronco intagliato. Comprende palestra multifunzione e scivolo a spirale H 200 cm.

Great adventure castle with two towers connected by a rope bridge. Access by: net, wall climbing and carved trunk. Includes multipurpose gym and a spiral slide H 200 cm.





Castello Himalaya

ART. 015750 scivolo PE
ART. 015751 scivolo INOX

1278 x 1519 h 470 cm

1650 x 1725 cm

3-14

-215,35
Kg
CO₂

Grande castello a quattro torri con piani di gioco a 20, 150 e 200 cm. Comprende una vasta gamma di sistemi per il gioco e l'attività motoria.

Big castle with four towers with platforms at 20, 150 and 200 cm. Includes a wide range of systems for the game and gym activity.

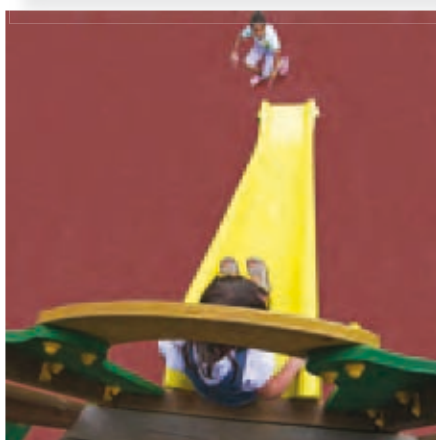

I ponti oscillanti possono essere forniti con pedana di sicurezza.

All swinging bridges can be provided with safety platform.

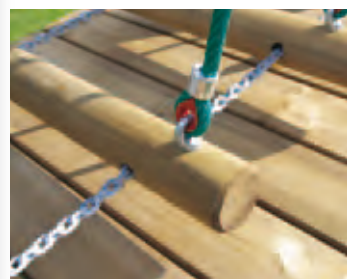



Castello Himalaya Maxi

ART. 015755 scivolo PE

ART. 015756 scivolo INOX

1832 x 1769 h 470 cm

2030 x 2020 cm

3-14

-332,50
Kg
CO₂

Grande castello a sei torri con piani di gioco a 20, 150 e 200 cm. Studiato per soddisfare tutte le esigenze di un grande parco giochi accessibile anche ai diversamente abili.

Big castle with six towers, with playing platforms at 20, 150 and 200 cm. Designed to meet all the needs of a large playground accessible to the disabled people.



Galeone

ART. 015142 scivolo PE

ART. 015042 scivolo inox

540 x 460 h 330 cm

905 x 860 cm

3-12

-67,77
Kg
CO₂

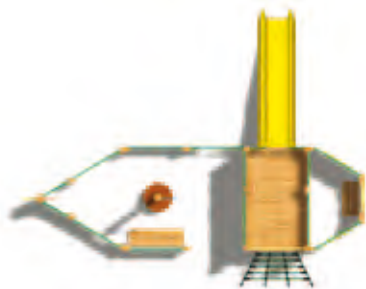

Goletta

ART. 015143 scivolo PE

ART. 015043 scivolo inox

770 x 1240 h 430 cm

1160 x 1550 cm

3-14

-140,2
Kg
CO₂

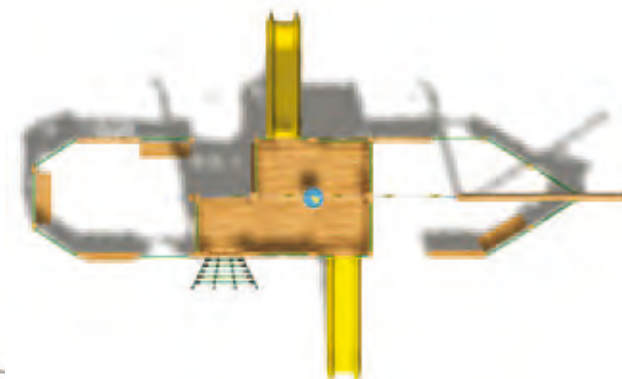

Giochi tematici multifunzione su più livelli dotati di torrette, arrampicate, scivoli, banchetti, tavolini e panchine.

Multi-function playgrounds on different levels, including: towers, nets, climber, slides, banks, tables and benches.



Vellero

ART. 015044

-265,75
kg
CO₂

1030 x 1700 h 760 cm

1430 x 1960 cm

3-14



Impianto tematico multifunzione dallo straordinario potere attrattivo, dotato di una vasta area per il gioco e la socializzazione, adatto anche ai diversamente abili.

Attractive multifunction thematic playground unit with a large area for play and socialization, also suitable for the special needs people.

Disponibile in vari colori.
Available in various colors.

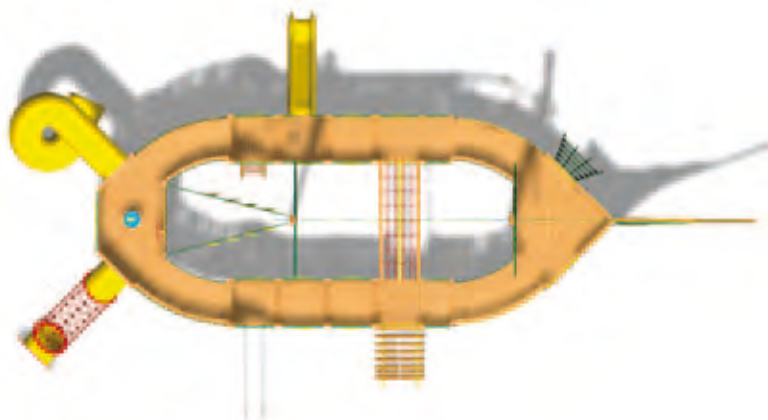

TORRI E CASTELLI "COLORE" TOWERS AND CASTLES "COLORE"

Una collana di giochi integrati nella linea Young, studiati per le situazioni dove il colore è di primaria importanza come scuole, centri commerciali, parchi tematici spiagge ecc... Struttura in legno ABILAM e pannellature in resistente polietilene riciclabile spessore 20mm. Scivoli in polietilene con pista di scorrimento in vetroresina.

A special series of games in the Young line, designed for situations where color is of primary importance as for schools, shopping centers, themeparks, beaches etc. Wood structure in ABILAM and durable recyclable polyethylene thickness 20mm. Slides in polyethylene with fiberglass sliding tracks.





Torre Soffio

ART. 014035

23,08
Kg
CO₂

123 x 389 h 294 cm

414 x 721 cm

2-12

Torri con piano di gioco a 15, 100 o 150 cm da terra, salita attraverso una scaletta a gradini o rete di arrampicata.

Scivoli in polietilene e pista di scorrimento in vetroresina.

Towers with the playin platform at 15, 100 or 150 cm above the ground, access by stair or a net. The slides made of polyethylene and fiberglass sliding track.



Torre Brezza

ART. 014055

-16,48
Kg
CO₂

180 x 391 h 344 cm

475 x 735 cm

3-12



Torre Bora

ART. 014070

-24,77
Kg
CO₂

↕ 423 x 446 h 344 cm

▭ 700 x 874 cm

👤 3-12



Torre Ghibli

ART. 014075

-26,06
Kg
CO₂

↕ 339 x 446 h 344 cm

▭ 663 x 796 cm

👤 3-12



Torri con piano di gioco a 150 cm da terra, attrezzate con altalena oppure palestra multi-funzione.

Towers with the platform at 20 and 150 cm from the ground, equipped with a swing or multi-purpose gym.



Torre Mistral

ART. 014080

-34,35
Kg
CO₂

446 x 638 h 344 cm

854 x 920 cm

3-12



Castello Levante

ART. 014105

↓ 497 x 501 h 344 cm

792 x 838 cm

3-12

-57,82
Kg
CO₂



Castelli con piani di gioco a 100 e 150 cm da terra, attrezzati con scivoli, ponti sospesi, pertica a dischi e palestra multi-funzione.

Castles with platforms at 100 and 150 cm from the ground, equipped with slides, suspension bridges, pole disks and multi-purpose gymnasium.



I ponti oscillanti possono essere forniti con pedana di sicurezza.

All the swinging bridges can be provided with safety platform.



Castello Pampero

ART. 014110

↓ 497 x 653 h 344 cm

838 x 948 cm

3-12

-55,66
Kg
CO₂



Castello Monsone

ART. 014115

 652 x 689 h 344 cm

 948 x 1020 cm

 3-12

-63,95
Kg
CO₂

Castello con piani di gioco a 100 e 150 cm da terra, attrezzato con scivolo, ponte su funi, altalena e palestra multi-funzione.

Towers with the platform at 100 and 150 cm above the ground, equipped with a rope bridge, swing and multi-purpose gym.





Castello Turbine
ART. 014122

-89,46
Kg
CO₂

732 x 769 h 344 cm
1072 x 1103 cm
3-12

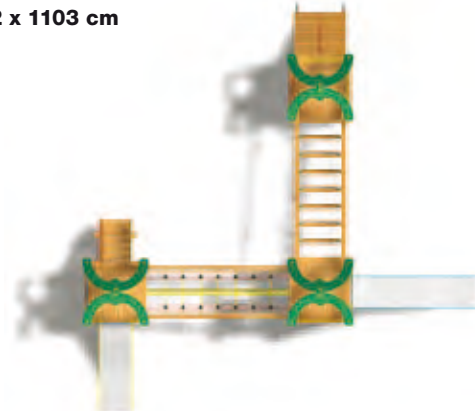

Castelli multi-torre con piani di gioco a 15, 100 e 150 cm da terra, attrezzati con diversi ponti sospesi ed accessori per il gioco, la socializzazione e l'attività motoria.

Multi-tower castles with platforms at 15, 100 and 150 cm from the ground, equipped with several suspension bridges and accessories for playing, socialization, and gym activity.



Castello Tornado

ART. 014140

-96,55
Kg
CO₂

 1035 x 1059 h 344 cm

 1351 x 1364 cm

 3-12

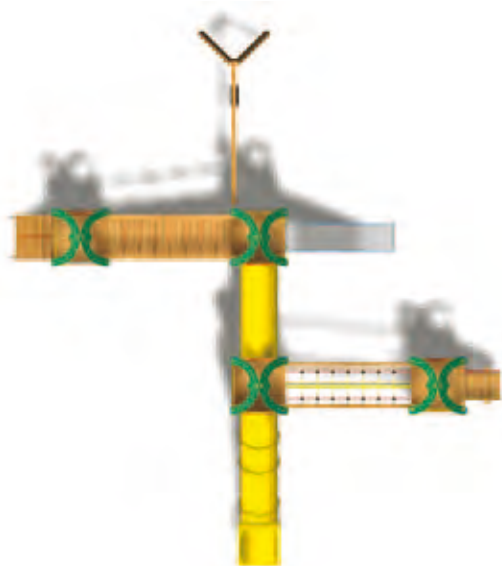



NIDI - LINEA CAMELOT

NURSERY - CAMELOT LINE

Il tema fiabesco dei castelli.

Fatto di torri, maghi e fate, incanta i bambini da sempre.

Le strutture modulari, disposte su vari livelli, aiutano i bambini a muoversi in piena sicurezza e ad interagire attraverso i giochi di ruolo.

Una linea completamente nuova, creativa e originale, esclusiva di Legnolandia. La struttura portante è in legno lamellare Superwood a sezioni contrapposte 90x90 mm. Le parti colorate sono in polietilene riciclabile al 100%, resistente ad ogni sollecitazione e ai raggi UV, che non richiede alcuna manutenzione.

I giochi sono adatti per l'utilizzo sia all'aria aperta che in spazi interni.

The magical theme of castles.

Children have always been enchanted by images of towers, wizards and fairies.

These modular multilevel structures allow the child to move in complete safety and interact through role playing. This all-new, creative and original range is designed and produced exclusively by Legnolandia.

The main structure is made of 90x90 mm superwood-two elements are joined in opposing sections. All coloured elements are in 100% recyclable, UV resistant and maintenance-free polyethylene. These items of play equipment are suitable for both outdoor and indoor installation.

I Wood

Esclusivi giochi in legno per l'infanzia
Exclusive wooden play equipment for kids

*Richiedi il catalogo specifico:
info@legnolandia.com*

LA LINEA CAMELOT E' DISPONIBILE ANCHE NELLA VERSIONE "TUTTOLEGNO NATURALE"



Il tema fiabesco dei castelli con la naturalità del legno.

Fatto di torri, maghi e fate, incanta i bambini da sempre. Le strutture modulari, disposte su vari livelli, aiutano i bambini a muoversi in sicurezza e ad interagire attraverso i giochi di ruolo. La struttura è in legno lamellare sezione 90x90 mm, le pareti in pannelli lamellari di larice spessore 20 mm. Tutto è realizzato in LEGNO NATURALE conservandone profumo e colore, virtù impareggiabili del materiale più amato al mondo. Sono studiati principalmente per l'utilizzo in spazi coperti, ma possono anche essere forniti con verniciatura a base d'acqua per uso all'esterno. Giochi certificati secondo le norme EN 1176 in vigore.

The theme of fairy-tale castles with the naturalness of the wood.

Towers, magicians and fairies enchant children since always. The modular structures, arranged on different levels, help children to move safely and interact through role-playing games. The structure is made of laminated wood in 90x90 mm, the walls are made of larch wood panels, 20 mm thick. Everything is made of NATURAL WOOD preserving scent and colour, incomparable virtues of the most popular material in the world. They are designed primarily for use in covered spaces, but can also be supplied with a protective varnish to make them suitable for outdoor use. The equipment is certified according to EN 1176 standards.

I  Wood







Angolo Re Artù

ART. 017036

↕ 146 x 146 h 120 cm

▭ 446 x 446 cm

👤 1-6



Un castello medioevale in quattro metri. Fuori i viandanti o gli attaccanti, dentro, con comode panchine, i difensori e il re. E due piccole finestre per comunicare...

A medieval castle in just four metres. Outside the castle walls, travellers and foes, inside, seated on comfortable benches, the defenders and king, with two small windows for communicating...

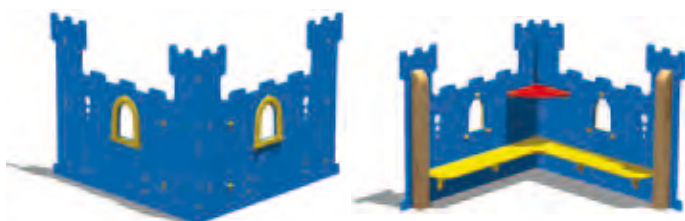

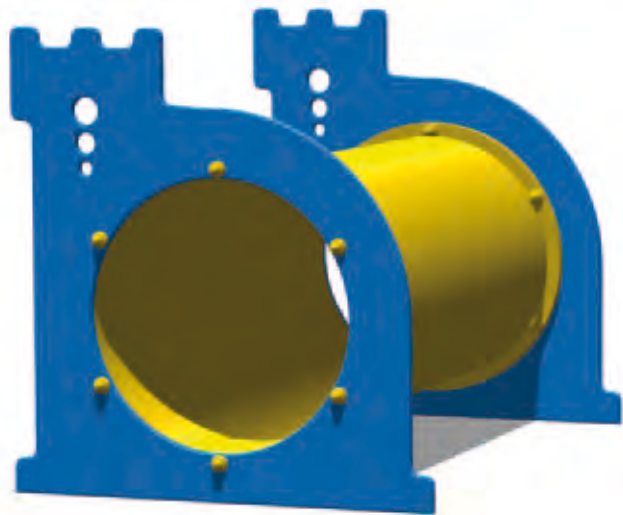

Tunnel Merlino

ART. 017037

↕ 98 x 127 h 103 cm

▭ 398 x 427 cm

👤 1-6





Ponticello Excalibur

ART. 017038

↕ 64 x 166 h 120 cm

▭ 364 x 463 cm

👤 1-3





Torre Robin Hood

ART. 017040

↕ 64 x 193 h 145 cm

▭ 364 x 489 cm

👤 1-6



TORRI CON TRE DIVERSI TIPI DI ACCESSO

TOWERS WITH THREE DIFFERENT ACCESS OPTIONS

Per offrire qualcosa in più rispetto alle solite “scalette”, sono state progettate tre tipologie di accesso alle Torri, del tutto diverse. Tutte e tre le proposte sono pensate per agevolare, ma anche per rendere più avvincente la conquista del castello da parte dei bambini.

To offer something more interesting than the usual stairs, three completely different tower access solutions have been created. All three systems have been especially designed to make conquering the tower both easier and more exciting for children.

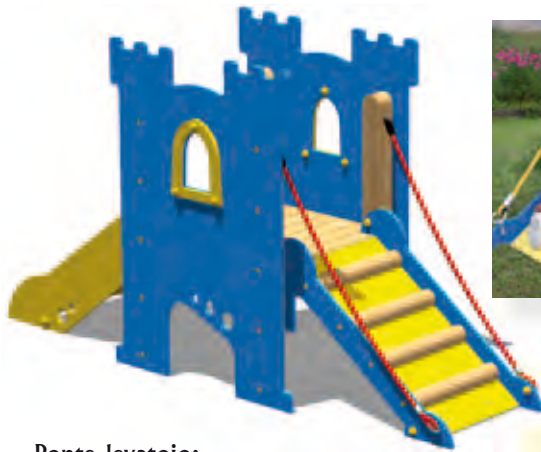

Ponte levatoio:

Permette una salita facile anche ai più piccoli frequentatori dei Nidi. Infatti è possibile salire sia camminandoci semplicemente sopra, con l'aiuto delle funi, sia a “gattoni”, grazie alle traversine in legno “fuori cuore”.

Drawbridge:

Created to make climbing into the tower easy even for the youngest child. The child may simply walk up the drawbridge, holding on to the ropes, or crawl up on their hands and knees, while crosspieces in heart pine provide extra grip.

-7,86
Kg
CO₂

Torre Parsifal - Levatoio

ART. 017048

82 x 262 h 145 cm

382 x 562 cm

1-6

Scala a gradini agevolati:

La scala è dotata di “asole”, che permettono il primo approccio ai gradini anche con l'aiuto delle mani.

Stairs with easy steps:

Slots in the staircase offer extra grip for little hands, for children learning to use steps for the first time.

-7,26
Kg
CO₂

Torre Parsifal - Scala

ART. 017050

82 x 240 h 145 cm

382 x 540 cm

1-6

Rampa curva con appigli:

Offre ai bambini un elemento di apprendimento in più: la gravità può essere vinta posizionando le mani e i piedi in un certo modo. L'istinto innato dell'arrampicata permetterà a tutti di raggiungere la torre in piena sicurezza.

Curved ramp with handholds and footholds:

This system offers an additional learning element for children as they realize that they can overcome gravity by positioning their hands and feet correctly. By using their natural climbing instinct, all children will be able to reach the tower in complete safety.

-7,26
Kg
CO₂

Torre Parsifal - Rampa

ART. 017051

82 x 236 h 145 cm

382 x 536 cm

1-6

TORRI ANGOLARI CON TRE TIPI DI ACCESSO

CORNER TOWERS WITH THREE DIFFERENT ACCESS OPTIONS

Le Torri angolari sono la soluzione ideale all'interno, o nei casi in cui si disponga di uno spazio limitato. Come per le Torri presentate nelle pagine precedenti, si può scegliere fra tre tipi di accesso: Ponte levatoio, Scala a gradini o Rampa.

I GIOCHI SONO ADATTI PER L'UTILIZZO SIA ALL'ARIA APERTA CHE IN SPAZI INTERNI.

Corner towers are the ideal solution for indoor use or outdoor installations with limited space. As with the towers described on the previous page, there are three different entrance options to choose from: drawbridge, stairs and ramp.

THE GAMES ARE SUITED FOR BOTH INDOOR AND OUTDOOR USE.



Torre Lancillotto Levatoio

ART. 017052

181 x 174 h 145 cm

481 x 474 cm

1-6

-7,86
kg
CO₂



Torre Lancillotto Scala

ART. 017053

158 x 174 h 145 cm

458 x 474 cm

1-6

-7,26
kg
CO₂



Torre Lancillotto Rampa

ART. 017054

155 x 174 h 145 cm

455 x 474 cm

1-6

-7,26
kg
CO₂

IL MONDO DEI CASTELLI

THE WORLD OF CASTLES

Grazie al sistema modulare, si possono unire tra loro più Torri, collegandole con Ponti e Tunnel, e completandole con Rampe, Scale a gradini e Ponte levatoio. In queste pagine proponiamo alcuni Castelli con 2 o 3 Torri, ma le composizioni possono essere molte di più, create liberamente unendo i diversi elementi in base alla fantasia e allo spazio a disposizione.

The modular design allows that multiple towers are joined together with bridges and tunnels, to then complete the resulting castle with ramps, stairs and drawbridges. Shown here are a number of castles created with 2 or 3 towers, but many more compositions are possible by freely combining different elements, with creativity and available space as the only limits.

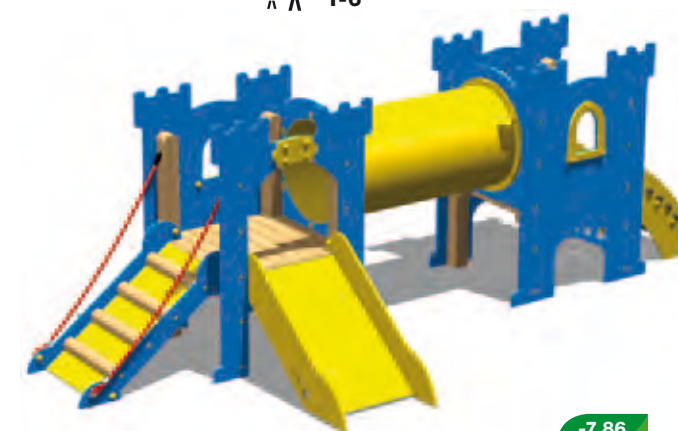

COLLEGAMENTI TRA LE TORRI

LINKS BETWEEN TOWERS

Si ispirano al magico tema dei castelli medioevali. Ponti e Tunnel portano da una Torre all'altra del Castello, per raggiungere i luoghi più fantasiosi ed anche quelli più "temuti", come la prigione...

Drawing inspiration from the magical theme of medieval castles, a range of bridges and tunnels leading from one tower in a castle to the next and taking the child to fantastic places – or even fearful dungeons.

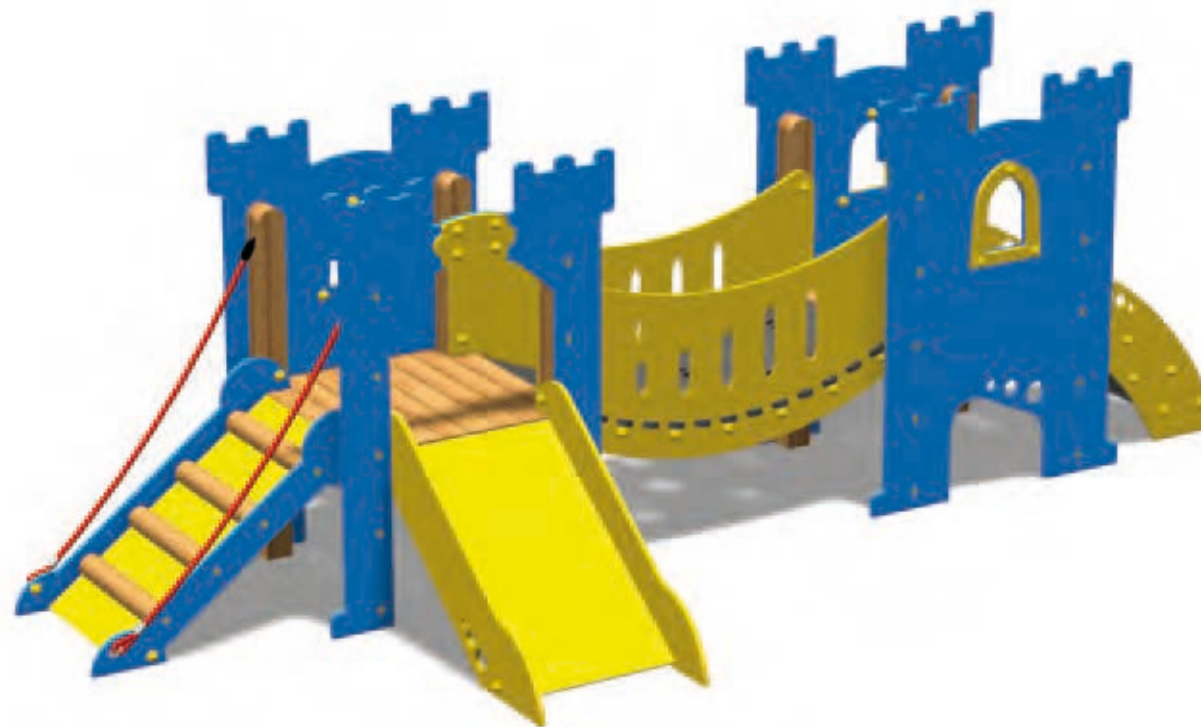

-7,86
kg
CO₂

Castello Saladino

ART. 017062

176 x 441 h 145 cm

474 x 741 cm

1-6



-7,86
Kg
CO₂

Castello Templari

ART. 017065

441 x 386 h 145 cm

741 x 675 cm

1-6

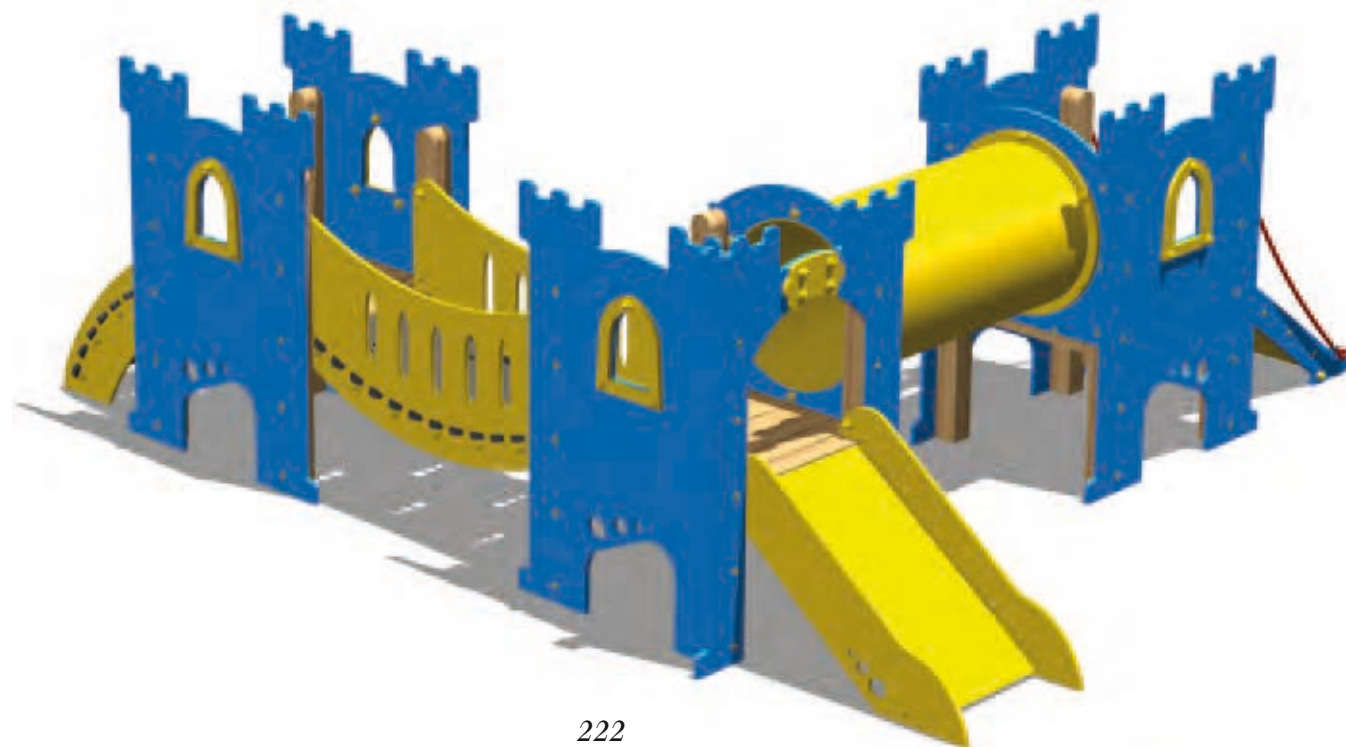
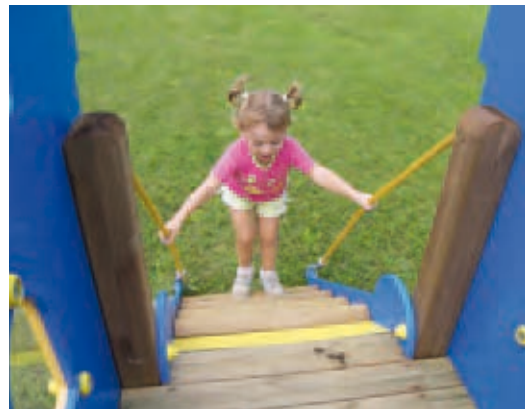



-7,86
Kg
CO₂

Castello Sir-Bis

ART. 017066

↕ 390 x 386 h 145 cm

▭ 675 x 690 cm

👤 1-6

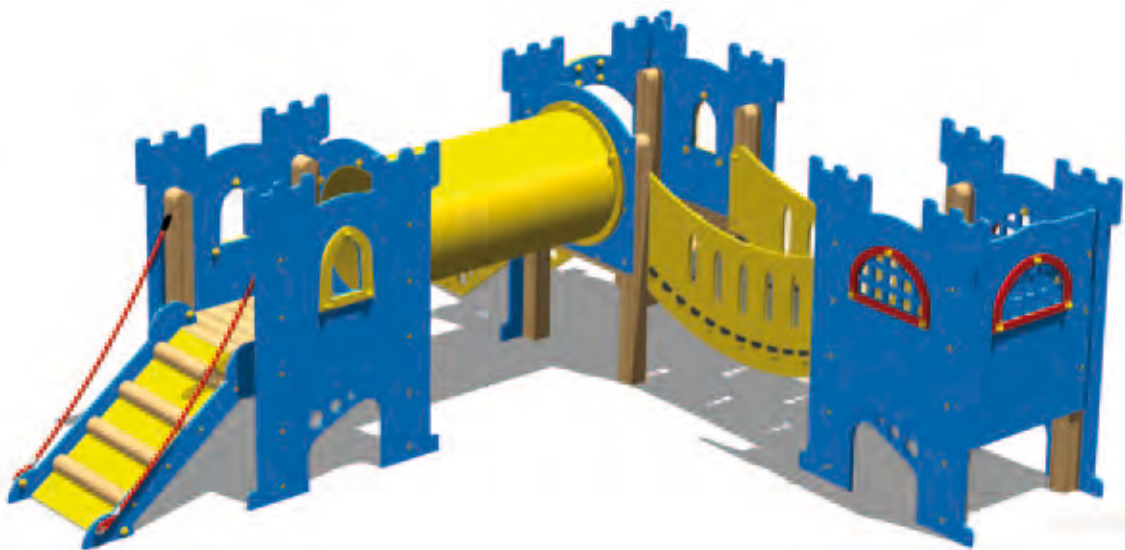



NIDI - LINEA TUTTIFRUTTI

NURSERY - TUTTIFRUTTI LINE

Una proposta innovativa di grande originalità e simpatia.

La frutta, allegra e colorata, diventa un gioco ideale per i bambini più piccoli, che imparano subito a riconoscere il loro posto preferito, di "lavoro" o di gioco. La linea TUTTIFRUTTI contribuisce a rendere ancora più sereno e gradevole l'ambiente del "Nido", in sintonia con la semplicità e i valori della natura.

Giochi ed arredi sono costruiti in legno di Abete Bianco certificato PEFC con pannelli decorativi in polietilene colorato.

La versione "I LOVE WOOD" è costruita interamente in LEGNO NATURALE conservandone profumo e colore, virtù impareggiabili del materiale più amato al mondo.

An innovative, highly original and fun range.

An innovative, highly original and fun range. Fruit – cheerful and brightly coloured by definition – becomes the perfect play environment for very young children, as it allows them to quickly learn to identify their favourite activity places and games.

The TUTTIFRUTTI range contributes to making the day care centre a calmer, more pleasant place for children, in harmony with the simplicity and values of nature.

The equipment are made of Silver Fir wood PEFC certified, with decorative polyethylene wall panels.

The version "I LOVE WOOD" is built entirely in NATURAL WOOD keeping scent and color, incomparable virtues of the most popular material in the world.



Primipassi Doppio

ART. 017102

↙ 193 x 41 h 87 cm

▭ 300 x 150 cm

👤 1-3



Attraverso la curiosità per forme e colori, PRIMIPASSI stimola l'attività motoria dei più piccoli e, con l'aiuto della sbarra inclinata, li porta gradualmente al gioco di livello superiore.

Through the curiosity for shapes and colours, PRIMIPASSI stimulates the motoric activity of the youngest and, with the aid of the inclined bar, brings them gradually to the higher level.



Primipassi

ART. 017101

↙ 60 x 40 h 60 cm

▭ 150 x 150 cm

👤 1-3

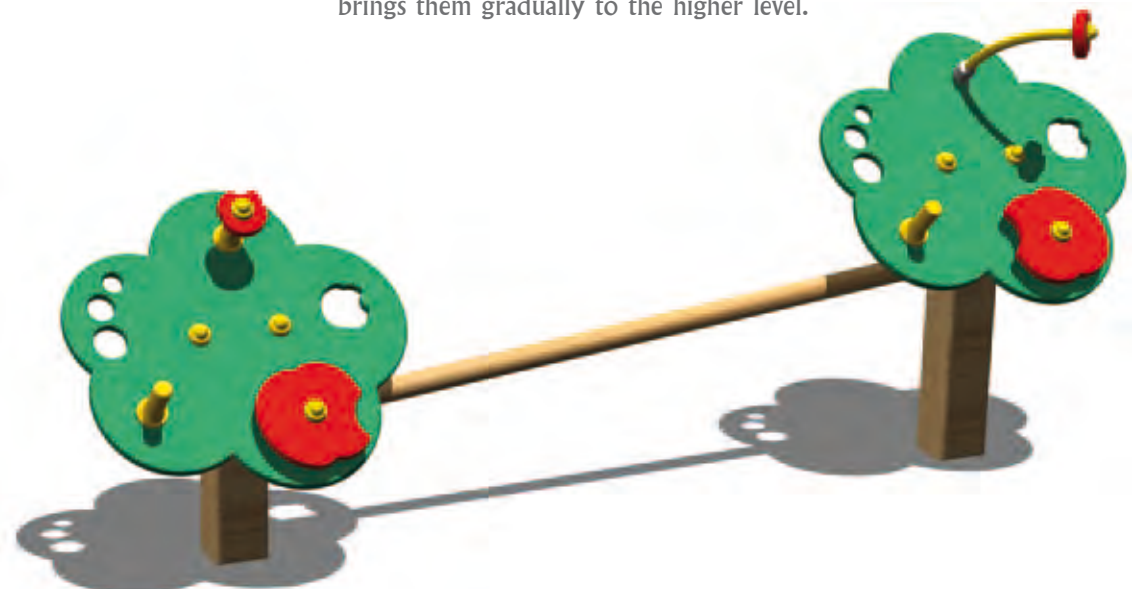



Lavagna

ART. 017103

↕ 97 x 45 h 110 cm

▭ 150 x 300 cm

👤 1-6

La LAVAGNA è un "albero" frondoso, che può essere corredato da un piccolo tavolo e tre sgabelli colorati.

LAVAGNA is a leafy "tree" which can be teamed with a small table and three coloured stools.



Lavagna con arredo

ART. 017104

↕ 130 x 130 h 110 cm

▭ 300 x 300 cm

👤 1-6





Banana Climb

ART. 017201

85 x 85 h 55/69 cm

385 x 385 cm

2-6



Dopo aver imparato a camminare, l'arrampicata è una delle prime attività motorie dei bambini. I pioli della BANANA CLIMB hanno un diametro che agevola la presa delle mani. Per i più piccoli, la facile arrampicata sul piano ricurvo del MANDARINO CLIMB è stimolante e sicura grazie agli appigli smussati.

Having learnt to walk, climbing is one of the first motoric activities of children. The pegs of the BANANA CLIMB have a diameter that facilitates grasping with ones hands. For smaller children the easy climb on the curved level of the MANDARINO CLIMB is stimulating and safe, thanks to the rounded grips.

Mandarino Climb

ART. 017205

80 x 82 h 65 cm

380 x 382 cm

1-3

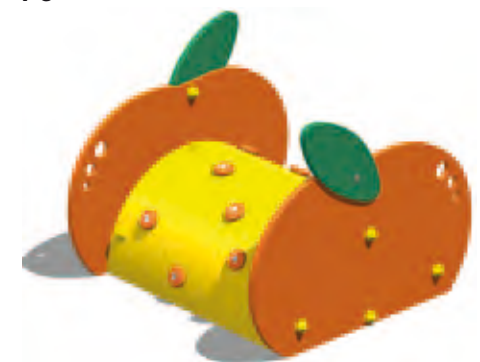



Banana Spring

ART. 017113

↓ 125 x 23 h 82 cm

▭ 225 x 325 cm

👤 2-8



Fragola Spring

ART. 017114

↓ 46 x 72 h 83 cm

▭ 250 x 250 cm

👤 1-6

GIOCHI A MOLLA ad uno, due e tre posti, coloratissimi e molto sicuri.

One, two or three-seat SPRING ROCKERS. Very colourful and safe.

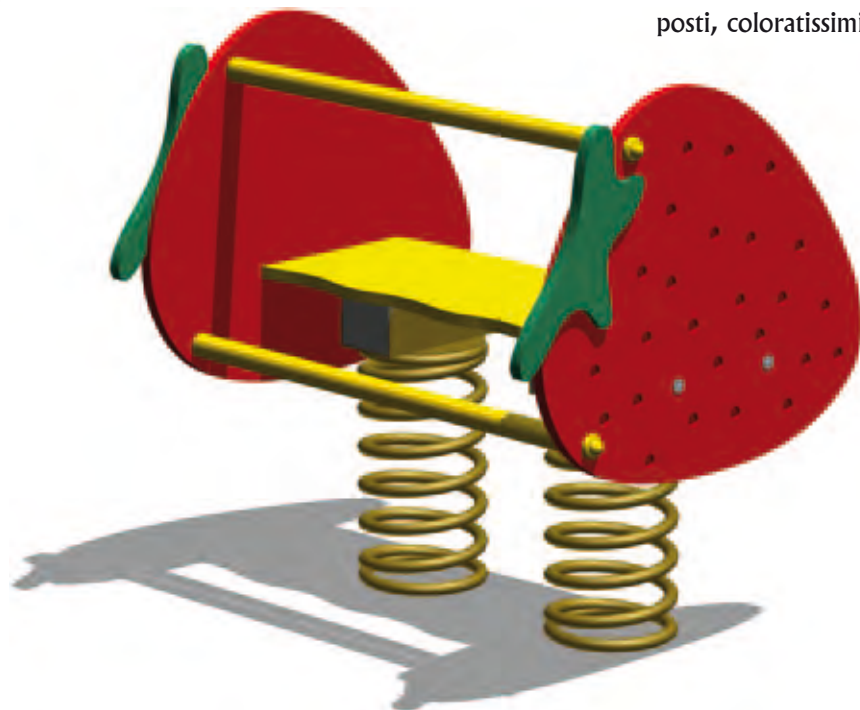

Fragola Multi Spring

ART. 017124

↓ 86 x 72 h 83 cm

▭ 290 x 250 cm

👤 1-6





SABBIERA dotata di un comodo coperchio scorrevole realizzato in laminato ad alta resistenza, per proteggere la sabbia da animali e intemperie.

SANDBOX with a convenient sliding lid in high resistant laminate protects sand from animals and bad weather.

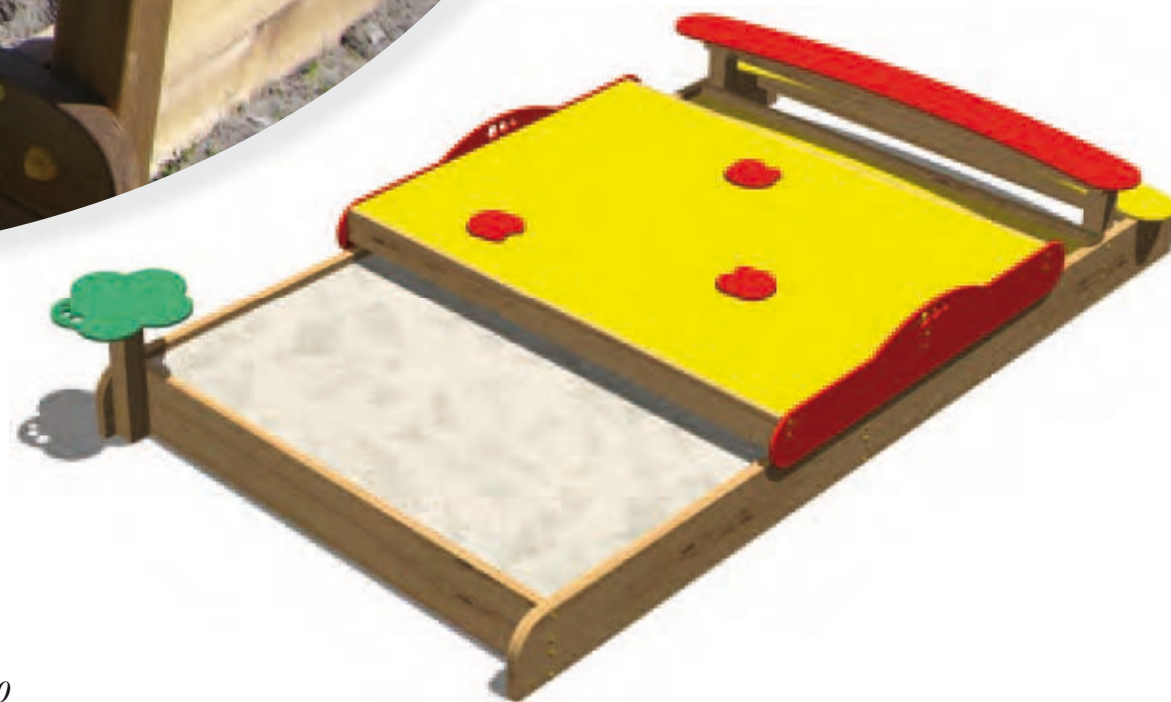

-27,91
Kg
CO₂

Sabbiera Grillo

ART. 017116

↕ 234 x 419 h 58 cm

⬡ 500 x 700 cm

👤 1-10

-9,02
Kg
CO₂

Sabbiera Coccinella

ART. 017115

↓ 234 x 220 h 52 cm

▭ 400 x 400 cm

👤 1-10

Per questa SABBIERA è disponibile la copertura con telo igienico in PVC microforato.

I KIT ARREDO FRUTTA sono ideali per creare angoli attrezzati a piacere. Panchette e piani di lavoro sono in polietilene, che non richiede alcuna manutenzione.

A hygienic cover sheet in micro-perforated PVC is available for this SANDBOX. The FRUIT FURNISHING KITS are ideal for creating accessorised corners using your imagination. Benches and worktops are in polyethylene, requiring no maintenance.



Seduta Mela

ART. 017119

↓ Ø 20 h 24/30 cm



Tavolino Pera

ART. 017120

↓ Ø 60 h 44/54 cm



Gruppo Arredo Frutta

ART. 017118

↓ 145 x 150 h 44/54 cm

👤 1-10

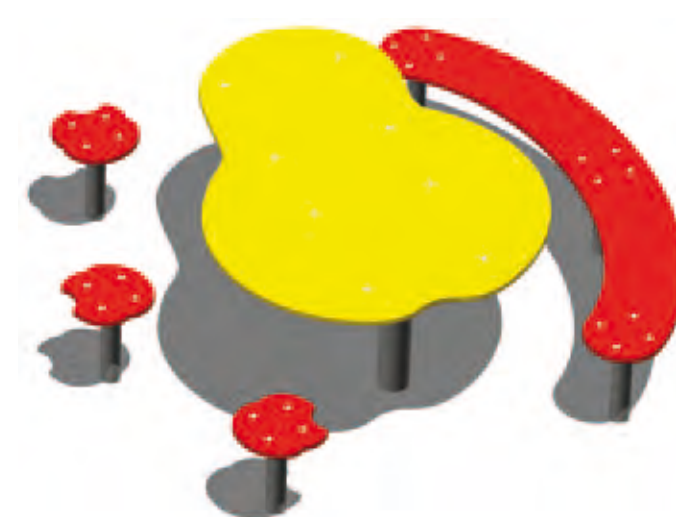



I bambini hanno sempre sognato di arrampicarsi sugli alberi. Le Torri e i Castelli TUTTIFRUTTI sono pensati per regalare anche ai più piccoli le prime conquiste.



Children have always dreamt of climbing on trees. The TUTTIFRUTTI Towers and Castles have been designed to offer younger children their first conquests.

-7,26
Kg
CO₂

Torre Melo Scala Pioli

ART. 017150

↕ 206 x 90 h 140 cm

▭ 505 x 382 cm

👤 1-6



-7,26
Kg
CO₂

Torre Melo Scala Gradini

ART. 017151

↕ 240 x 82 h 140 cm

▭ 540 x 382 cm

👤 1-6





Il passaggio da un “albero” all’altro attraverso una rete sospesa, sempre in assoluta sicurezza, abitua il bambino a prendere confidenza con il vuoto e ad assumere fiducia nelle sue capacità motorie.

Moving from one tree to the next across a suspended net, in total safety, gets the child used to gaining confidence with empty spaces and learning to trust in his motoric abilities.



Disponibile anche nella versione “tutto legno” naturale.
Available also in “all natural wood” version.



-7,26
Kg
CO₂

Castello Melo Scala Gradini

ART. 017161

↕ 470 x 82 h 140 cm

▭ 763 x 382 cm

👤 1-6



-7,26
Kg
CO₂

Castello Melo Scala Pioli

ART. 017160

↕ 435 x 90 h 140 cm

👤 729 x 382 cm

1-6

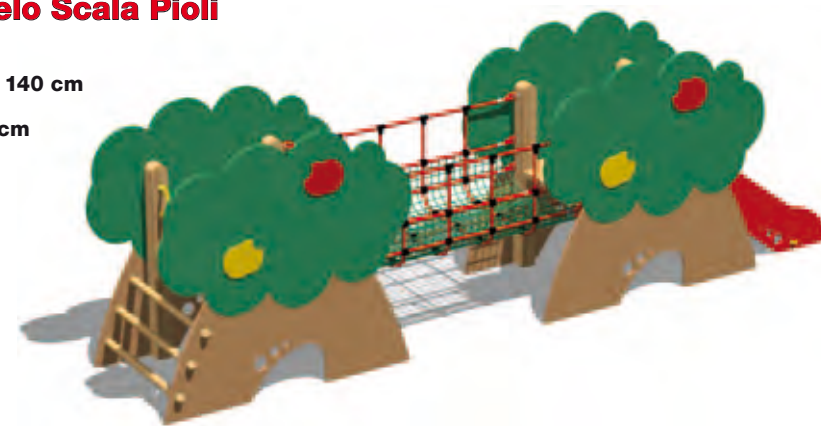



LINEA SICUREZZA SAFETY LINE

Pavimentazioni di sicurezza anti-trauma: complementi ideali e necessari di ogni parco giochi.

Un parco giochi sicuro non si compone solo di sovrastrutture di qualità ma richiede anche pavimentazioni di sicurezza che ammortizzino l'impatto di eventuali cadute, secondo le norme di sicurezza. Legnolandia dispone di un'ampia gamma di materiali collaudati e dotati di certificato di sicurezza ed è disponibile a studiare, caso per caso, le soluzioni tecnicamente ed economicamente più adatte.

Safety playground flooring: ideal and necessary accessories in every playground.

Fitted with a safety flooring that can absorb falls, in accordance with safety standards.

Legnolandia has a wide range of tested materials, all of which have a safety certificate, and we offer you our help for customized projects in order to provide you the most suitable solutions from both a technical and financial point of view.



Sono disponibili molti accessori in gomma riciclata per la protezione delle superfici per il gioco e l'attività in esterno e per la loro bordatura e delimitazione. La posa viene fatta preferibilmente su asfalto e cemento, ma è possibile anche su prato, predisponendo uno strato di sabbia. Il fissaggio delle piastre avviene mediante appositi spinotti, con l'aggiunta di collante.

Many recycled rubber accessories to protect, frame and delimit play and outdoor activities are available. Accessories can be laid on asphalt and concrete, but also on lawns, first spreading a sand-layer. Tile's anchoring is obtained through connecting pins, adding glue.



TABELLA PER LA SCELTA DEI MATERIALI AD ASSORBIMENTO DI IMPATTO - Norma EN1176-1
TABLE FOR THE CHOICE OF IMPACT ABSORBING MATERIALS - Standard EN1176-1

Materiale <i>Material</i>	Dimensione <i>Size</i>	Profondità minima <i>Minimum depth</i>	Altezza di caduta critica <i>Critical fall height</i>
Prato/ terreno naturale <i>lawn and natural ground</i>			≤ 100 cm
Corteccia sminuzzata <i>Shredded bark</i>	20 - 80 mm	200	≤ 200 cm
		300	≤ 300 cm
Trucioli in legno <i>Wood shavings</i>	5 - 30 mm	200	≤ 200 cm
		300	≤ 300 cm
Sabbia <i>Sand</i>	0,2 - 2 mm	200	≤ 200 cm
		300	≤ 300 cm
Ghiaia <i>Gravel</i>	2 - 8 mm	200	≤ 200 cm
		300	≤ 300 cm
Gomma - Rubber	come prova HIC (EN 1177) - as HIC test (EN 1177)	come certificato - as certificate	
Note:	Considerare lo spostamento del materiale sfuso durante il gioco (aggiungere 100 mm)		
Note:	Consider the movement of material during play (add 100 mm)		

Il perimetro della pavimentazione non ha vincoli di forma e dimensione, e può essere chiuso con una bordatura in gomma, legno o cemento.

The flooring perimeter has no shape or size limit, and can be finished with a rubber, wood or concrete framing.

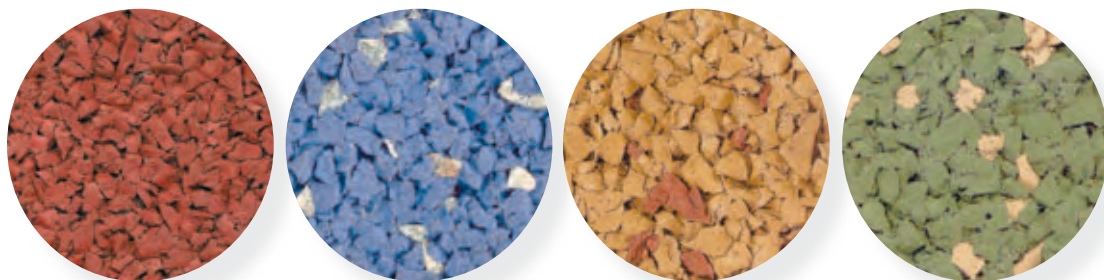

I parchi gioco su superficie in materiale naturale (ghiaia, sabbia, cippato, corteccia) sono più divertenti, economici e rispettosi dell'ambiente.

The playgrounds on natural surface (grave, sand, wood chippings, bark) are more fun, cheap and environmentally friendly.

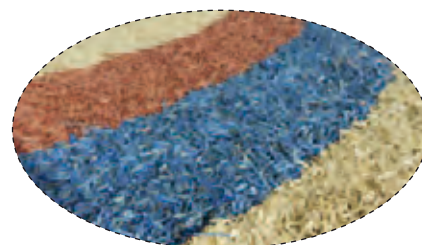

Legnolandia consiglia pavimentazioni in trucioli di legno naturale
 Legnolandia suggest Wood Chippings (shavings) natural ground covering





ARREDO SCUOLE SCHOOL FURNISHINGS

Una gamma completa di elementi d'arredo ed accessori costruiti in legno e polietilene riciclabili, studiati per i bambini delle scuole dell'infanzia e per i piccoli utenti dei parchi gioco.

Queste attrezzature contribuiscono a rendere più gradevole e funzionale l'ambiente delle scuole e dei parchi gioco, in sintonia con la semplicità della natura. Arredi costruiti in legno di Abete Bianco certificato PEFC con pannelli decorativi in polietilene colorato. La versione "I LOVE WOOD" è costruita interamente in LEGNO NATURALE conservandone profumo e colore, virtù impareggiabili del materiale più amato al mondo.

A complete range of furniture and accessories made of recycled wood and polyethylene, designed for children in nursery schools and for small playground users

These facilities contribute to make the environment of schools and playgrounds more pleasant and functional, in harmony with the simplicity and values of nature. The equipment are made of Silver Fir wood PEFC certified, with decorative polyethylene wall panels. The version "I LOVE WOOD" is built entirely in NATURAL WOOD keeping scent and color, incomparable virtues of the most popular material in the world.



-2,50
Kg
CO₂

Gruppo Mela

ART. 017110

132 x 94 h 24/44 cm

1-3

I gruppi di arredo MELA e PERA sono composti da tavoli e panche. Le parti colorate sono in polietilene, che non richiede manutenzione.

The MELA and PERA furnishing compositions consist of tables and benches. The coloured parts are in polyethylene, requiring no maintenance.



-1,44
Kg
CO₂

Tavolo Mela

ART. 017130

60 x 94 h 44 cm

1-3

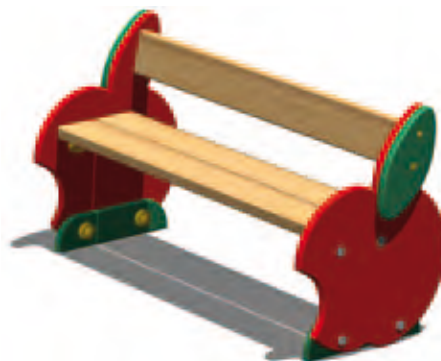

-0,56
Kg
CO₂

Panca Mela

ART. 017105

34 x 94 h 24 cm

1-3





Tavolo Pera

ART. 017131

60 x 94 h 44 cm

1-3

-1,44
Kg
CO₂

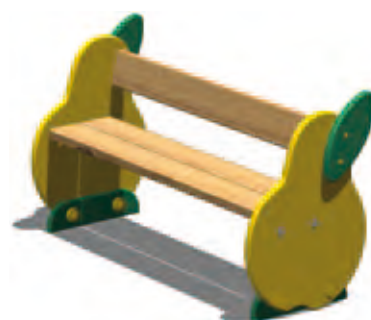

Panca Pera

ART. 017106

34 x 94 h 24 cm

1-3

-0,56
Kg
CO₂



Gruppo Pera

ART. 017111

132 x 94 h 24/44 cm

1-3

-2,50
Kg
CO₂

I  Wood



Disponibile anche nella versione "tutto legno" naturale.
Available also in "all natural wood" version.

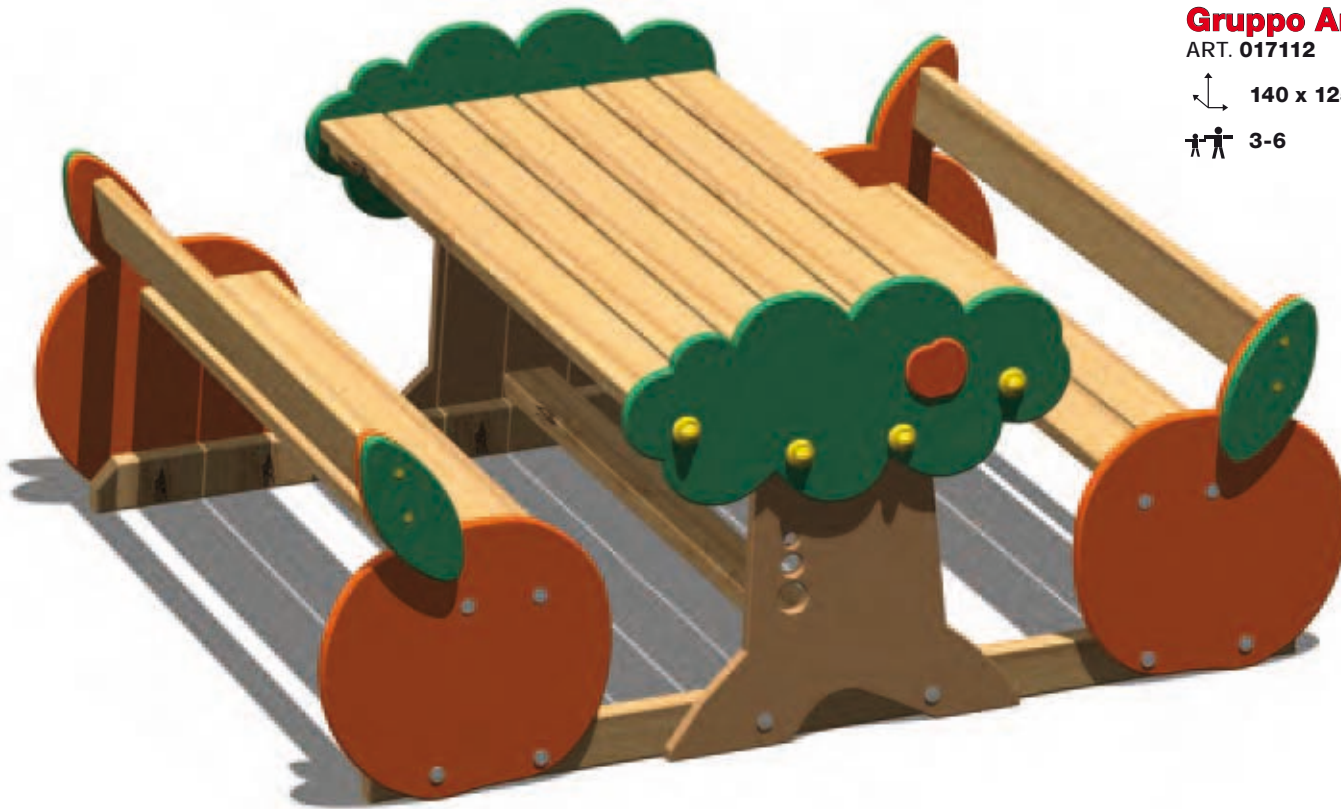

-3,09
Kg
CO₂

Gruppo Arancia

ART. 017112

↓ 140 x 125 h 30/54 cm

👤 3-6



Il gruppo di arredo ARANCIA è studiato per le scuole dell'infanzia (bimbi di 3-6 anni).

The ARANCIA furnishing composition has been designed for kindergartens (children from ages 3 to 6).



-1,87
Kg
CO₂

Tavolo Arancia

ART. 017138

↓ 60 x 125 h 54 cm

👤 3-6

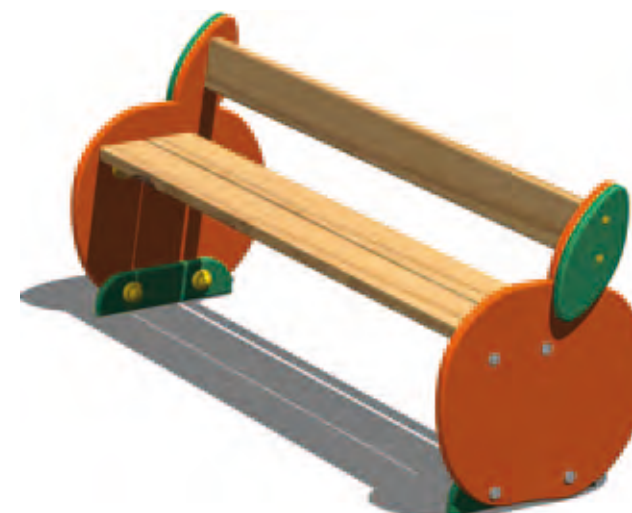

-0,73
Kg
CO₂

Panca Arancia

ART. 017107

↓ 38 x 125 h 30 cm

👤 3-6



Gruppo Arredo Frutta

ART. 017118

145 x 150 h 44/54 cm

1-10

I KIT ARREDO FRUTTA sono ideali per creare angoli attrezzati a piacere. Panchette e piani di lavoro sono in polietilene, che non richiede alcuna manutenzione.

The FRUIT FURNISHING KITS are ideal for creating accessorised corners using your imagination. Benches and worktops are in polyethylene, requiring no maintenance.



Lavagna con arredo

ART. 017104

130 x 130 h 110 cm

300 x 300 cm

1-6



Seduta Mela

ART. 017119

Ø 20 h 24/30 cm

1-10



Tavolino Pera

ART. 017120

Ø 60 h 44/54 cm

1-10



Banana Box

ART. 017145

80 x 125 h 80 cm

-7,90
kg
CO₂

Tutti i gruppi di arredo possono essere corredati da un CESTINO portarifiuti e dal BANANA BOX: un grande e comodo contenitore per i giochi, sia all'aria aperta che in ambienti interni.

All compositions can be teamed with a litter bin PERA and a container BANANA BOX: a spacious handy container for toys, usable both indoors and out.



Cestino Pera

ART. 017140

45 x 65 h 85 cm

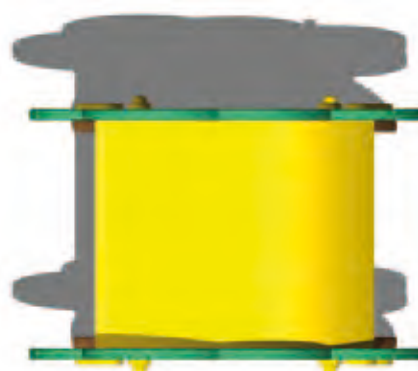



-4,11
Kg
CO₂

Gruppo D'Arredo Fruts

ART. 016105

↙ 130 x 120 h 50 cm

🧑 2-8

Elementi d'arredo per l'attività didattica in e out door, certificati secondo le norme UNI EN 1176.

Furniture items for indoor and outdoor educational activity certified according to UNI EN 1176 standards.

-1,28
Kg
CO₂

Panca Fruts senza Schienale

ART. 016100

↙ 29 x 120 h 27 cm

🧑 2-8



-1,38
Kg
CO₂

Panca Fruts con Schienale

ART. 016101

↙ 29 x 120 h 27/44 cm

🧑 2-8

-2,72
Kg
CO₂

Tavolo Fruts

ART. 016102

↙ 57 x 120 h 50 cm

🧑 2-8





-11,34
Kg
CO₂

Set Scuola Materna

ART. 011170

↕ 150 x 161 h 70 cm

👤 3-11

Soluzioni d'arredo per esterni, composte da tavoli e panche con o senza schienale, lunghezza 150 cm. Si possono fornire anche tavolo e panchine separate.

Outdoor furniture solutions, made up by tables and benches with or without backrest, length 150 cm. Table and benches can be supplied separately.



-4,11
Kg
CO₂

Panca Scuola Materna con Schienale

ART. 011175

↕ 150 x 55 h 70 cm

👤 3-11



-2,96
Kg
CO₂

Panca Scuola Materna senza Schienale

ART. 011180

↕ 150 x 45 h 40 cm

👤 3-11



-6,33
Kg
CO₂

Pic Nic Junior

ART. 071350

↓ 130 x 120 h 55 cm

2-8

Tavoli con sedute incorporate per attività all'aperto. Il modello "Pic Nic" è interamente in legno.

Tables with built-in seats for outdoor activities. The "Pic Nic" version is entirely made of wood.



-13,61
Kg
CO₂

Pic Nic Senior

ART. 071355

↓ 190 x 160 h 75 cm



REFERENZE REFERENCES

Abbiamo fornito attrezzature ad oltre 2000 comuni Italiani ed importanti città estere come Barcellona, Vienna, Atene, Jeddah, Medina, Odessa, Copenaghen, Budapest, Lisbona, Kiev ed altre. Lavoriamo inoltre con prestigiose società tra le quali Benetton, Fiat, Michelin, Autogrill, Loacker, Autostrade, Gardaland.

We have supplied equipment to over 2000 Italian and foreign cities such as Barcelona, Vienna, Athens, Jeddah, Medina, Odessa, Copenhagen, Budapest, Lisbon, Kiev and others. We work with prestigious companies such as Benetton, Fiat, Michelin, Autogrill, Loacker, Autostrade, Gardaland.



CERTIFICAZIONI CERTIFICATIONS

Legnolandia è certificata secondo il Sistema di Qualità UNI EN ISO 9001:2008
e il Sistema di Gestione Ambientale UNI EN ISO 14001:2004

Legnolandia is certified in compliance with the UNI EN ISO 9001:2008
Quality System and the UNI EN ISO 14001:2004 Environmental Quality Management System



DIREZIONE E DIVISIONE
GIOCHI - ARREDO URBANO
Via Nazionale, 280
33024 Forni di Sopra (UD) Italy
Tel. (+39) 0433 88307
Fax (+39) 0433 88551

info@legnolandia.com
www.legnolandia.com